

# MCO IP69k – protective housing for DNT outdoor applications





## MCO IP69k – protective housing for DNT\* outdoor applications



**Digital networking** | The demand for outdoor cabling solutions is growing unabated. This is due to modern network and IP interface technologies, which are essential for digitization. These will enable

the networking and deployment of surveillance cameras, sensors and digital traffic signs, as well as wireless access points.

**METZ CONNECT Outdoor** | Our MCO IP69k protective enclosures provide reliable protection for your permanent outdoor connections. They are not only completely dustproof and waterproof, but also resistant to ozone, UV radiation and salt water. Furthermore, they withstand high temperatures,

strong vibrations and high-pressure jet cleaning, thus providing reliable protection against external interference. The flexible and easy-to-install solutions have been specially designed to accommodate and protect field-assembled cables, pre-assembled patch cables and fiber optic (FO) connections.

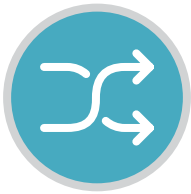
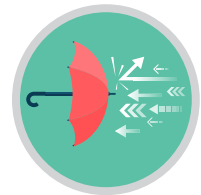

**Flexible & reliable** | Our universally applicable protective housings for outdoor applications are available in three different versions, and cover all conceivable applications in practice. The three variants of the protective housings have been specially designed for free installation, as well as for wall, DIN rail, quick and pole mounting. In addition, we also offer a solution for wall or housing feed-through.

Thanks to the adapter plates included in the delivery contents, countless combinations are possible with various modules, plug-in connectors, and cable connectors, regardless of whether it is a matter of accommodating and protecting field-assembled cables or pre-assembled patch cables and fiber optic (FO) connections.

\*DNT = Data Network Technology





# Structure



DUST AND WATERPROOF  
RESISTANT TO OZONE, UV RADI-  
ATION AND SALT WATER



IP69K, IP67  
AND IP66

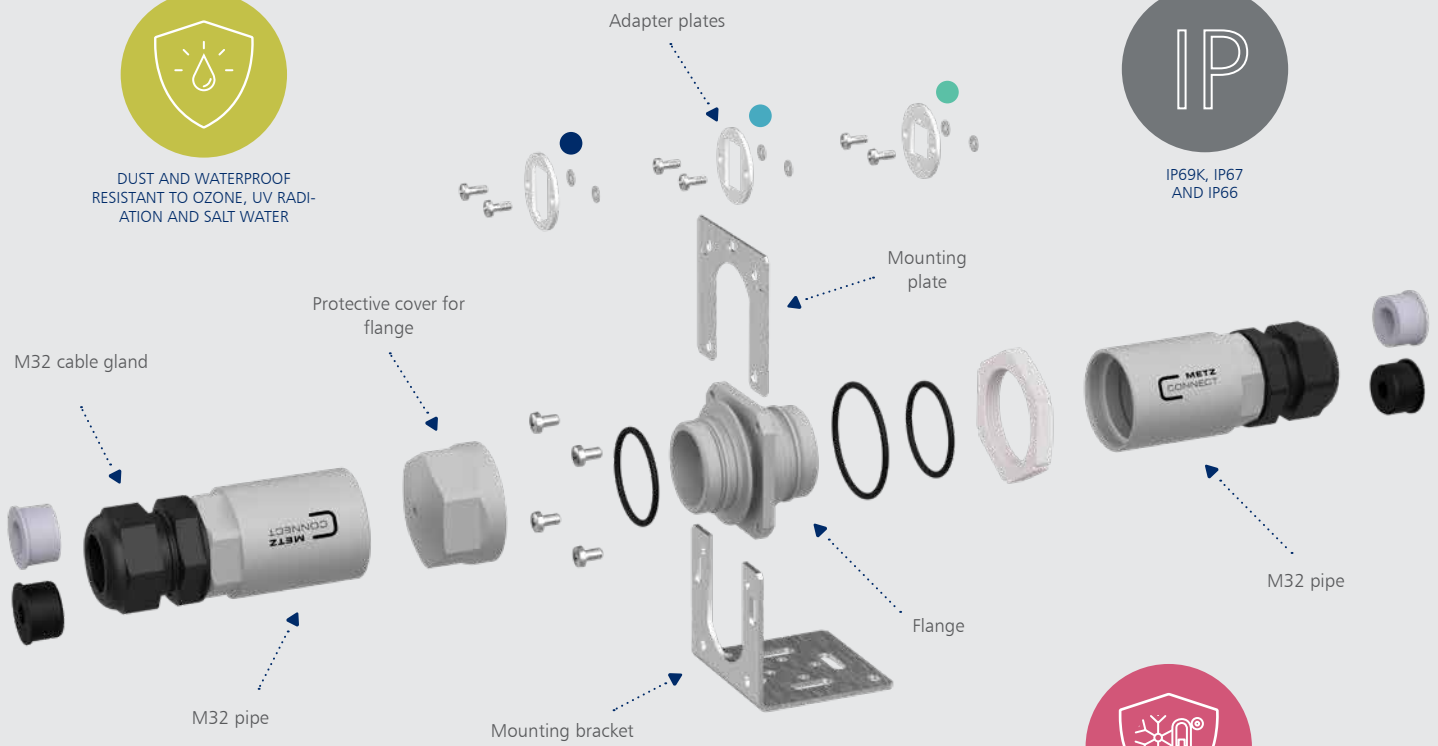

UNIVERSALLY AND  
FLEXIBLY APPLICABLE



HIGH PRESSURE JET,  
TEMPERATURE AND  
VIBRATION RESISTANT

- MC module
- Keystone
- Fiber optic (FO)



## Variant

### MCO IP69k – set for free laying

Part Number: 14040000-E



- > universally and flexibly applicable
- > completely dust and waterproof
- > resistant to ozone, UV radiation and salt water
- > resistant to high-pressure jet cleaning, high temperatures, and strong vibrations
- > tested according to IP69k, IP67 and IP66
- > M32 anodized aluminum tubes and flange
- > incl. M32 cable glands (PA) with sealing inserts, O-rings, and adapter plates for MC module, keystone and fiber optic (FO) components, for clean mounting inside the flange
- > suitable for cable sheath diameters from 4.5 to 15 mm

### MCO IP69k – set with mounting bracket

Part Number: 14040010-E



- > designed for wall, top-hat rail, quick and pole mounting
- > incl. mounting bracket and mounting plate for quick and tool-free fixation of the flange
- > universally and flexibly applicable
- > completely dust and waterproof
- > resistant to ozone, UV radiation, and salt water
- > resistant to high-pressure jet cleaning, high temperatures, and strong vibrations
- > tested according to IP69k, IP67 and IP66
- > M32 anodized aluminum tubes and flange
- > incl. M32 cable glands (PA) with sealing inserts, O-rings, and adapter plates for MC module, keystone and fiber optic (FO) components, for clean mounting inside the flange
- > suitable for cable sheath diameters from 4.5 to 15 mm
- > Top-hat rail adapter not included in the delivery contents, P/N: 1308990111-I



## MCO IP69k – set wall and housing bushing

Part Number: 14040100-E



- > incl. M40 locknut (PA) for wall and housing mounting
- > universally and flexibly applicable
- > completely dust and waterproof
- > resistant to ozone, UV radiation, and salt water
- > resistant to high-pressure jet cleaning, high temperatures, and strong vibrations
- > tested according to IP69k, IP67, and IP66
- > M32 anodized aluminum tube and flange
- > incl. M32 cable gland (PA) with sealing inserts, O-rings, and adapter plates for MC module, keystone and fiber optic (FO) components, for clean mounting inside the flange
- > suitable for cable sheath diameters from 4.5 to 15 mm

## Accessories

### MCO IP69k – protective cover for flange

Part Number: 14040Z02-E



- > M32 anodized aluminum protective cover
- > suitable for P/N: 14040000-E, 14040010-E, 14040100-E



## Compatibility – MC module Adapter Plate

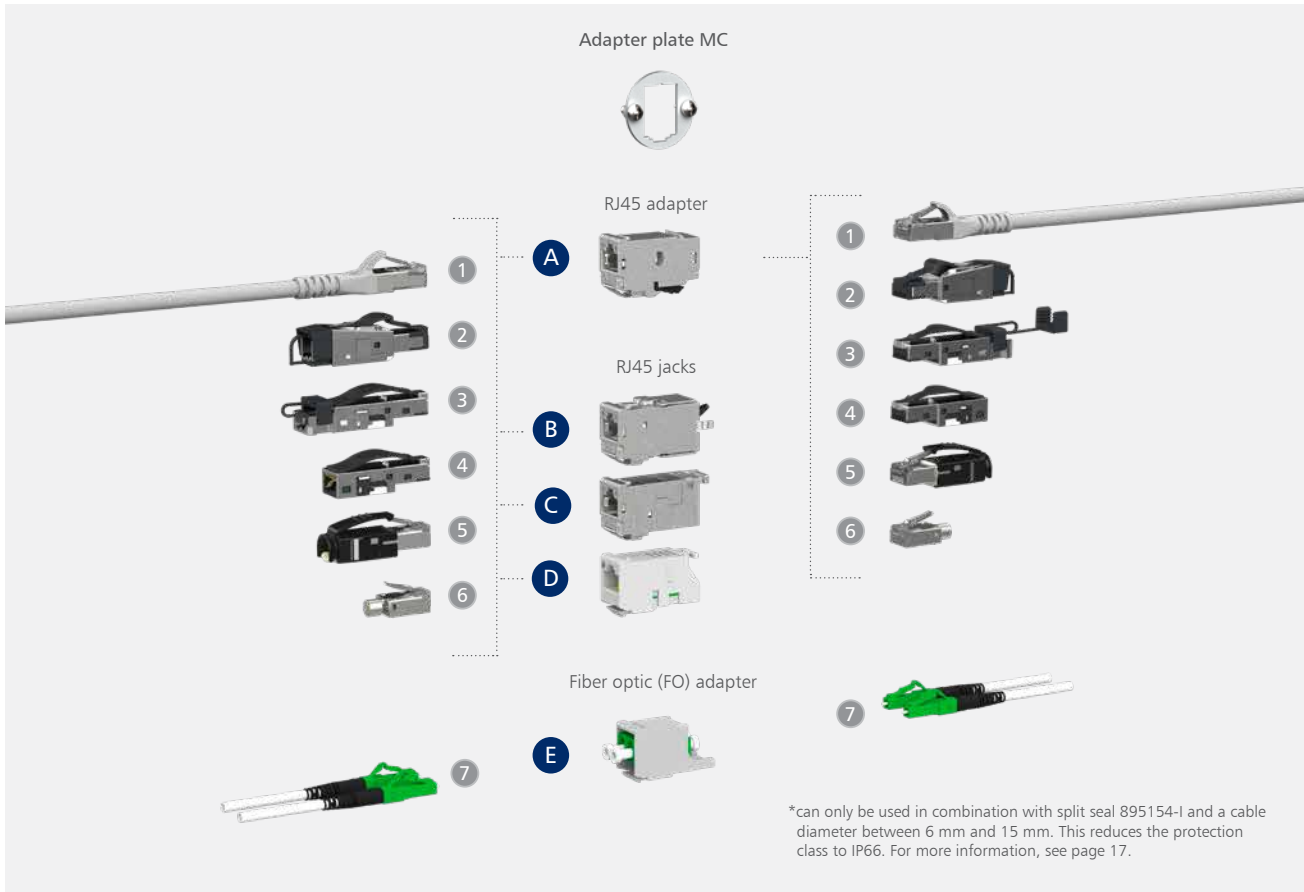

PRODUCT NAME	FEATURES	P/N	PRODUCT NAME	FEATURES	P/N
(A) E-DAT modul adapter	8(8) 180° Cl. E <sub>A</sub>	1309A0-I	(D) UAE modul white	Cat.6 jack T568A	130909-I
(B) C6 <sub>A</sub> module 180° jack	single	130B11-E		Cat.5e	130908-I-B1
	PU 12	130B11-Z		C6 <sub>A</sub>	130E405032-E
(B) 25Gmodul	single	130B11-25-E		C6 <sub>A</sub> , PU 100	130E405032-K
	PU 12	130B11-25-Z	(2) RJ45 field plug pro	40G	130H405032-E
(C) E-DAT modul Cat.6 <sub>A</sub> 8(8) jack, T568A	single	130910-I		25G	130G405032-E
	PU 12	130910-Z		C5 PROFINET	130E405032PE
(D) UAE modul 8(8) Cat.6 <sub>A</sub>	white	130A11-I	(3) E-DAT Industry field plug	Cat.6 Clas. E <sub>A</sub>	1401405012-I
	black	130A11-29-I		PROFINET	1401405012PI



PRODUCT NAME	FEATURES	P/N
④ E-DAT field plug short	Cat.6 Class E <sub>A</sub>	1401400812-E
⑤ E-DAT Industry connector	Cat.6 Class E <sub>A</sub>	1401505012-E
⑥ E-DAT Industry connector	Cat.6 Class E <sub>A</sub>	1401505010-E
⑤ OpDAT module LC-Duplex	OS2	15091071-I
	OM3	15091072-I
	OM4	15091075-I
	APC OS2	15091076-I
	OM2	1509107B-I
	OM5	1509107M-I
	⑦ OpDAT FAST™ Connector kit LC PC OM3/OM4 for buffers	PU 10
PU 20 incl. tool		1509MAJO002C-F
PU 100 incl. tool		1509MAJO010C-F
⑦ OpDAT FAST™ Connector kit LC PC OM3/OM4 for cable	PU 10	1509MKJO0010-F
	PU 20 incl. tool	1509MKJO002C-F
	PU 100 incl. tool	1509MKJO010C-F
⑦ OpDAT FAST™ Hybrid Connector kit LC APC OS2 for buffers	PU 10	1509QAJA0010-E
	PU 20 incl. tool	1509QAJA002C-E
	PU 100 incl. tool	1509QAJA010C-E
⑦ OpDAT FAST™ Hybrid Connector kit LC UPC OS2 for buffers	PU 10	1509QAJO0010-E
	PU 20 incl. tool	1509QAJO002C-E
	PU 100 incl. tool	1509QAJO010C-E

PRODUCT NAME	FEATURES	P/N
⑦ OpDAT FAST™ Hybrid Connector kit LC APC OS2 for cable	PU 10	1509QKJA0010-E
	PU 20 incl. tool	1509QKJA002C-E
	PU 100 incl. tool	1509QKJA010C-E
⑦ OpDAT FAST™ Hybrid Connector kit LC UPC OS2 for cable	PU 10	1509QKJO0010-E
	PU 20 incl. tool	1509QKJO002C-E
	PU 100 incl. tool	1509QKJO010C-E

## Compatibility – Keystone adapter plate

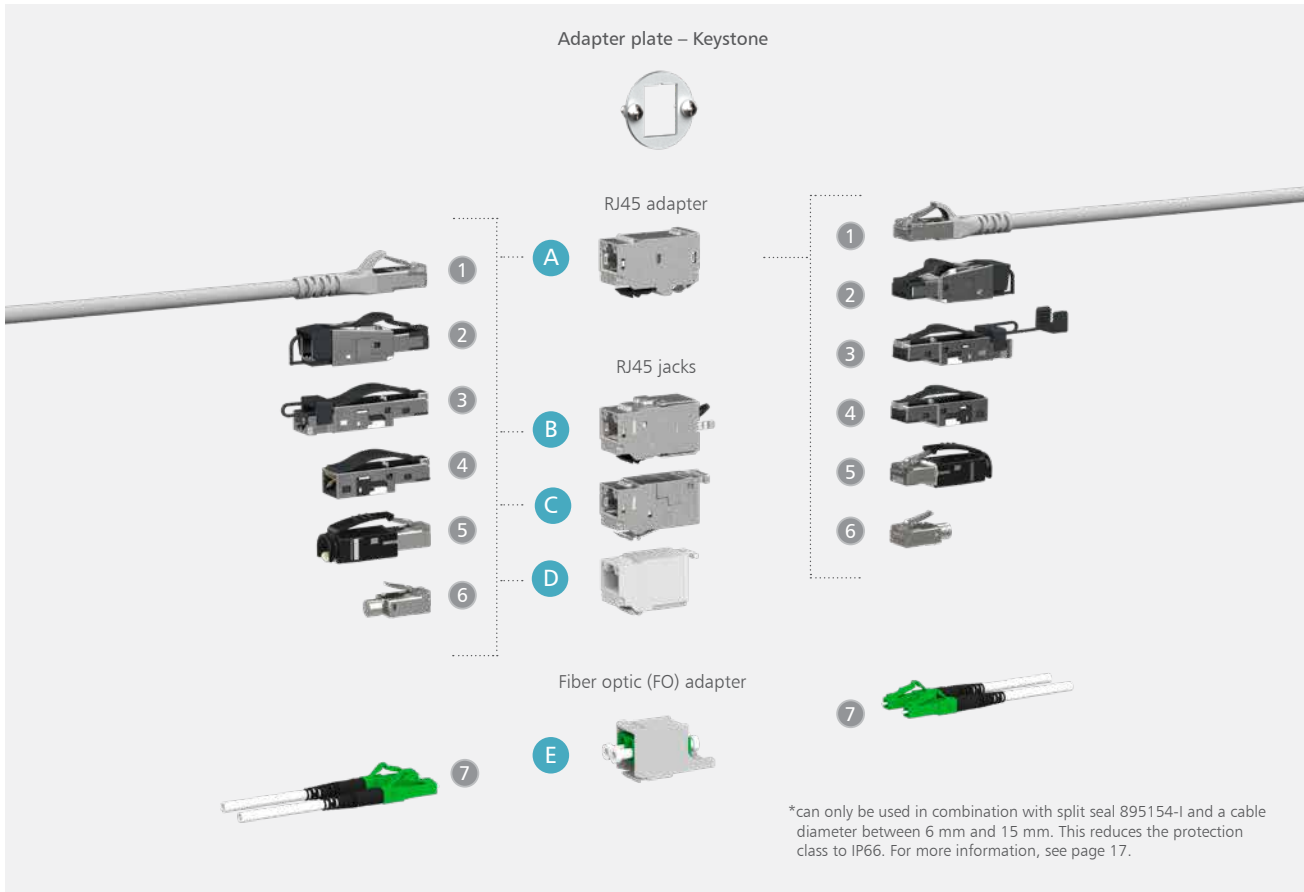

PRODUCT NAME	FEATURES	P/N	PRODUCT NAME	FEATURES	P/N
(A) E-DAT modul adapter	8(8) 180° Cl. E <sub>A</sub>	1309A0-I	(D) UTP modul	Cat.6 black	130A10-29-I-B1
(B) C6 <sub>A</sub> module K 180° jack – Keystone	single	130B21-E		Cat.5e white	130A08-I-B1
	PU 12	130B21-Z		C6 <sub>A</sub>	130E405032-E
(B) 25Gmodul – Keystone	single	130B21-25-E		C6 <sub>A</sub> , PU 100	130E405032-K
	PU 12	130B21-25-Z	(2) RJ45 field plug pro	40G	130H405032-E
(C) E-DAT modul Cat.6 <sub>A</sub> K jack – Keystone	single	130910KI		25G	130G405032-E
	PU 12	130910KZ		C5 PROFINET	130E405032PE
(D) UTP modul 8(8) Cat.6 <sub>A</sub>	white	130A11KI	(3) E-DAT Industry RJ45 field plug	Cat.6 Clas. E <sub>A</sub>	1401405012-I
	black	130A11-29KI		PROFINET	1401405012PI





PRODUCT NAME	FEATURES	P/N
④ E-DAT field plug short	Cat.6 Class E <sub>A</sub>	1401400812-E
⑤ E-DAT Industry connector	Cat.6 Class E <sub>A</sub>	1401505012-E
⑥ E-DAT Industry connector	Cat.6 Class E <sub>A</sub>	1401505010-E
⑤ OpDAT module LC-Duplex	OS2	15091071-I
	OM3	15091072-I
	OM4	15091075-I
	APC OS2	15091076-I
	OM2	1509107B-I
	OM5	1509107M-I
	⑦ OpDAT FAST™ Hybrid Connector kit LC UPC OS2 for buffers	PU 10
PU 20 incl. tool		1509QAJ0002C-E
PU 100 incl. tool		1509QAJ0010C-E
⑦ OpDAT FAST™ Hybrid Connector kit LC APC OS2 for cable	PU 10	1509QKJA0010-E
	PU 20 incl. tool	1509QKJA002C-E
	PU 100 incl. tool	1509QKJA010C-E
⑦ OpDAT FAST™ Hybrid Connector kit LC UPC OS2 for cable	PU 10	1509QKJO0010-E
	PU 20 incl. tool	1509QKJO002C-E
	PU 100 incl. tool	1509QKJO010C-E
⑦ OpDAT FAST™ Connector kit LC PC OM3/OM4 for buffers	PU 10	1509MAJO0010-F
	PU 20 incl. tool	1509MAJO002C-F
	PU 100 incl. tool	1509MAJO010C-F

PRODUCT NAME	FEATURES	P/N
⑦ OpDAT FAST™ Connector kit LC PC OM3/OM4 for cable	PU 10	1509MKJO0010-F
	PU 20 incl. tool	1509MKJO002C-F
	PU 100 incl. tool	1509MKJO010C-F
⑦ OpDAT FAST™ Hybrid Connector kit LC APC OS2 for buffers	PU 10	1509QAJA0010-E
	PU 20 incl. tool	1509QAJA002C-E
	PU 100 incl. tool	1509QAJA010C-E



## Compatibility – Fiber optic (FO) adapter plate

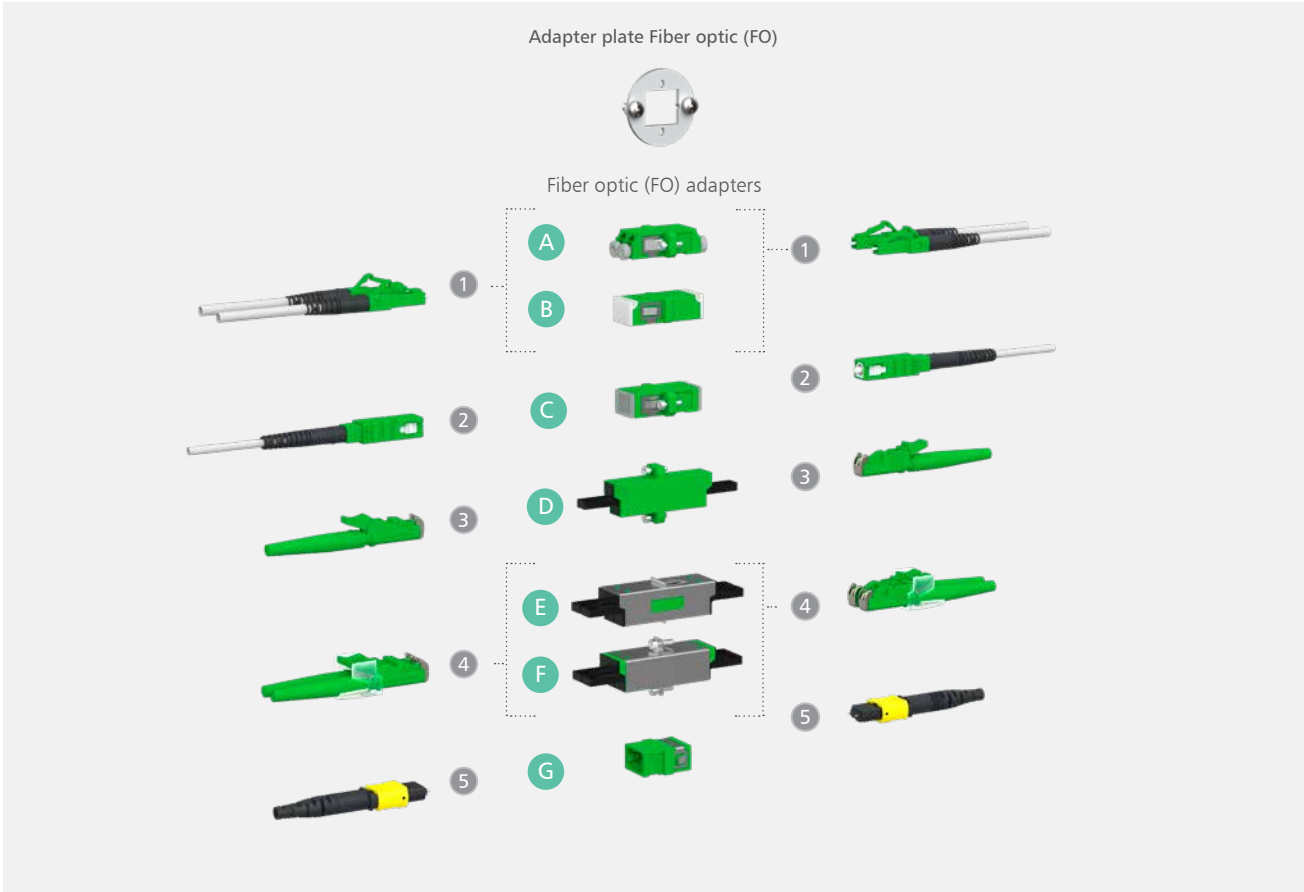

PRODUCT NAME	FEATURES	P/N	PRODUCT NAME	FEATURES	P/N
A OpDAT adapter LC-Duplex OS2	single	15090074-I	B OpDAT adapter LC-D APC OS2	Inside shutter	1509007G-I
	PU 50	15090074-50		C OpDAT adapter SC-Simplex APC OS2	single
	OM4	15090075-I	PU 50		1509001A-50
A OpDAT adapter LC-Duplex	OM4, PU 50	15090075-50	C OpDAT adapter SC-Simplex UPC OS2	single	1509001B-I
	OM5	1509007M-I		PU 50	1509001B-50
A OpDAT adapter LC-Duplex APC OS2	single	15090076-I	C OpDAT adapter SC-Simplex	OM2, PU 50	15090012-50
	PU 50	15090076-50		OM3	1509001C-I
A OpDAT adapter LC-Duplex OM3	single	15090077-I		C OpDAT adapter SC-Simplex	OM3, PU 50
	PU 50	15090077-50	OM4		1509001D-I
A OpDAT adapter LC-Duplex	OM2	1509007B-I	OM4, PU 50		1509001D-50



	PRODUCT NAME	FEATURES	P/N
Ⓒ	OpDAT adapter SC-Simplex APC OS2	with shutter	1509001H-I
Ⓒ	OpDAT adapter SC-Simplex OM5	OM5	1509001M-I
		OM5, PU 50	1509001M-50
Ⓓ	OpDAT adapter E2000-Simplex	OM3	1509005H-I
		OM4	1509005G-I
		OM5	1509005M-I
		OS2	15090058-I
		APC OS2	15090059-I
Ⓔ	OpDAT adapter E2000-Duplex with Snap-In mounting	OM2	1509005A-I
		OS2	1509005B-I
Ⓕ	OpDAT adapter E2000-Duplex with flange mounting	APC OS2	1509005C-I
		APC OS2	1509005F-I
Ⓖ	OpDAT adapter MTP® Type A	OM3	1509005MA-I
		OM4	1509007MA-I
		OM5	1509008MA-I
		APC OS2	1509009MA-I
Ⓖ	OpDAT adapter MTP® Type B	OM5	1509008MB-I
		OM4	1509007MB-I
①	OpDAT FAST™ Connector kit LC PC OM3/OM4 for buffers	PU 10	1509MAJO0010-F
		PU 20 incl. tool	1509MAJO002C-F
		PU 100 incl. tool	1509MAJO010C-F
①	OpDAT FAST™ Connector kit LC PC OM3/OM4 for cable	PU 10	1509MKJO0010-F
		PU 20 incl. tool	1509MKJO002C-F
		PU 100 incl. tool	1509MKJO010C-F
①	OpDAT FAST™ Hybrid Connector kit LC APC OS2 for buffers	PU 10	1509QAJA0010-E
		PU 20 incl. tool	1509QAJA002C-E
		PU 100 incl. tool	1509QAJA010C-E
①	OpDAT FAST™ Hybrid Connector kit LC UPC OS2 for buffers	PU 10	1509QAJO0010-E
		PU 20 incl. tool	1509QAJO002C-E
		PU 100 incl. tool	1509QAJO010C-E

	PRODUCT NAME	FEATURES	P/N
①	OpDAT FAST™ Hybrid Connector kit LC APC OS2 for cable	PU 10	1509QKJA0010-E
		PU 20 incl. tool	1509QKJA002C-E
		PU 100 incl. tool	1509QKJA010C-E
①	OpDAT FAST™ Hybrid Connector kit LC UPC OS2 for cable	PU 10	1509QKJO0010-E
		PU 20 incl. tool	1509QKJO002C-E
		PU 100 incl. tool	1509QKJO010C-E
②	OpDAT FAST™ Connector kit SC PC OM3/OM4 for buffers	PU 10	1509MAEO0010-F
		PU 20 incl. tool	1509MAEO002C-F
		PU 100 incl. tool	1509MAEO010C-F
②	OpDAT FAST™ Connector kit SC PC OM3/OM4 for cable	PU 10	1509MKEO0010-F
		PU 20 incl. tool	1509MKEO002C-F
		PU 100 incl. tool	1509MKEO010C-F
②	OpDAT FAST™ Hybrid Connector kit SC APC OS2 for buffers	PU 10	1509QAEA0010-E
		PU 20 incl. tool	1509QAEA002C-E
		PU 100 incl. tool	1509QAEA010C-E
②	OpDAT FAST™ Hybrid Connector kit SC UPC OS2 for buffers	PU 10	1509QAE00010-E
		PU 20 incl. tool	1509QAE0002C-E
		PU 100 incl. tool	1509QAE0010C-E
②	OpDAT FAST™ Hybrid Connector kit SC APC OS2 for cable	PU 10	1509QKEA0010-E
		PU 20 incl. tool	1509QKEA002C-E
		PU 100 incl. tool	1509QKEA010C-E
②	OpDAT FAST™ Hybrid Connector kit SC UPC OS2 for cable	PU 10	1509QKEO0010-E
		PU 20 incl. tool	1509QKEO002C-E
		PU 100 incl. tool	1509QKEO010C-E



## Compatibility – without adapter plate

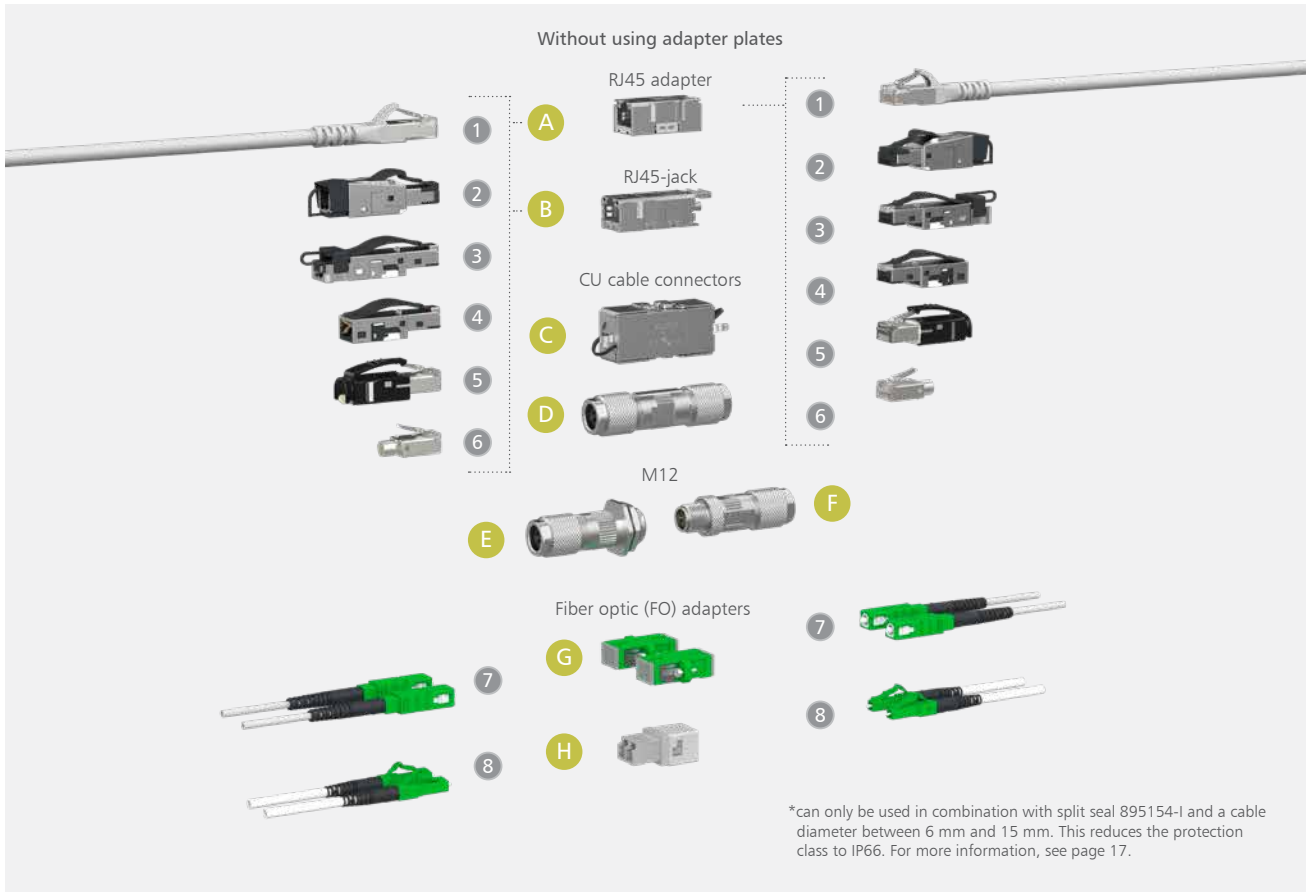

PRODUCT NAME	FEATURES	P/N
A E-DAT Industry RJ45 adapter insert	-	1401200810MI
	T568A	1401100810MI
B E-DAT Industry RJ45 field jack insert Cat. 6 Class E <sub>A</sub>	T568B	1401800810MI
	PROFINET	1401900810MI
C Cable connectors Class E <sub>A</sub>	180°	130863-04-E
D Cable connectors Class F <sub>A</sub>	-	130863-02-E
E M12 jack X-coded IP67, field-configurable	without flange	MMF881A315
	with flange	MMF881A315-0001
E M12 jack D-coded IP67, field-configurable	with flange	MMF881A115-0001
F M12 connector X-coded IP67, Cat.6 <sub>A</sub>	field-configurable, straight	MNF881A315-0001

PRODUCT NAME	FEATURES	P/N
F M12 connector D-coded IP67, Cat. 5	field-configurable, straight	MNF881A115
F M12 jack D-coded IP67	field-configurable	MMF881A115
G OpDAT adapter SC-Simplex APC OS2	single	1509001A-I
	PU 50	1509001A-50
G OpDAT adapter SC-Simplex UPC OS2	single	1509001B-I
	PU 50	1509001B-50
G OpDAT adapter SC-Simplex	OM2, PU 50	15090012-50
	OM3, PU 50	1509001C-50
G OpDAT adapter SC-Simplex	OM3	1509001C-I
	OM4	1509001D-I
G OpDAT adapter SC-Simplex	OM4, PU 50	1509001D-50



	PRODUCT NAME	FEATURES	P/N
Ⓒ	OpDAT adapter SC-Simplex APC OS2	with shutter	1509001H-I
		single	1509001M-I
Ⓒ	OpDAT adapter SC-Simplex OM5	PU 50	1509001M-50
		Multimode (MM)	1402300820MI
Ⓗ	OpDAT Industry LC-D adapter insert	Singlemode (SM)	1402L00820MI
		C6 <sub>A</sub>	130E405032-E
		C6 <sub>A</sub> ,PU 100	130E405032-K
②	RJ45 field plug pro	40G	130H405032-E
		25G	130G405032-E
		C5 PROFINET	130E405032PE
③	E-DAT Industry RJ45 field plug	Cat.6 Class E <sub>A</sub>	1401405012-I
		PROFINET	1401405012PI
④	E-DAT field plug short	Cat.6 Class E <sub>A</sub>	1401400812-E
⑤	E-DAT Industry connector	Cat.6 Class E <sub>A</sub>	1401505012-E
⑥	E-DAT Industry connector	Cat.6 Class E <sub>A</sub>	1401505010-E
		PU 10	1509MAEO0010-F
⑦	OpDAT FAST™ Connector kit SC PC OM3/OM4 for buffers	PU 20 incl. tool	1509MAEO002C-F
		PU 100 incl. tool	1509MAEO010C-F
		PU 10	1509MKEO0010-F
⑦	OpDAT FAST™ Connector kit SC PC OM3/OM4 for cable	PU 20 incl. tool	1509MKEO002C-F
		PU 100 incl. tool	1509MKEO010C-F
		PU 10	1509QAEA0010-E
⑦	OpDAT FAST™ Hybrid Connector kit SC APC OS2 for buffers	PU 20 incl. tool	1509QAEA002C-E
		PU 100 incl. tool	1509QAEA010C-E
		PU 10	1509QAE00010-E
⑦	OpDAT FAST™ Hybrid Connector kit SC UPC OS2 for buffers	PU 20 incl. tool	1509QAE0002C-E
		PU 100 incl. tool	1509QAE0010C-E

	PRODUCT NAME	FEATURES	P/N
		PU 10	1509QKEA0010-E
⑦	OpDAT FAST™ Hybrid Connector kit SC APC OS2 for cable	PU 20 incl. tool	1509QKEA002C-E
		PU 100 incl. tool	1509QKEA010C-E
		PU 10	1509QKEO0010-E
⑦	OpDAT FAST™ Hybrid Connector kit SC UPC OS2 for cable	PU 20 incl. tool	1509QKEO002C-E
		PU 100 incl. tool	1509QKEO010C-E
		PU 10	1509MAJO0010-F
⑧	OpDAT FAST™ Connector kit LC PC OM3/OM4 for buffers	PU 20 incl. tool	1509MAJO002C-F
		PU 100 incl. tool	1509MAJO010C-F
		PU 10	1509MKJO0010-F
⑧	OpDAT FAST™ Connector kit LC PC OM3/OM4 for cable	PU 20 incl. tool	1509MKJO002C-F
		PU 100 incl. tool	1509MKJO010C-F
		PU 10	1509QAJA0010-E
⑧	OpDAT FAST™ Hybrid Connector kit LC APC OS2 for buffers	PU 20 incl. tool	1509QAJA002C-E
		PU 100 incl. tool	1509QAJA010C-E
		PU 10	1509QAJO0010-E
⑧	OpDAT FAST™ Hybrid Connector kit LC UPC OS2 for buffers	PU 20 incl. tool	1509QAJO002C-E
		PU 100 incl. tool	1509QAJO010C-E
		PU 10	1509QKJA0010-E
⑧	OpDAT FAST™ Hybrid Connector kit LC APC OS2 for cable	PU 20 incl. tool	1509QKJA002C-E
		PU 100 incl. tool	1509QKJA010C-E
		PU 10	1509QKJO0010-E
⑧	OpDAT FAST™ Hybrid Connector kit LC UPC OS2 for cable	PU 20 incl. tool	1509QKJO002C-E
		PU 100 incl. tool	1509QKJO010C-E



## Application examples – set with mounting bracket

Quick assembly

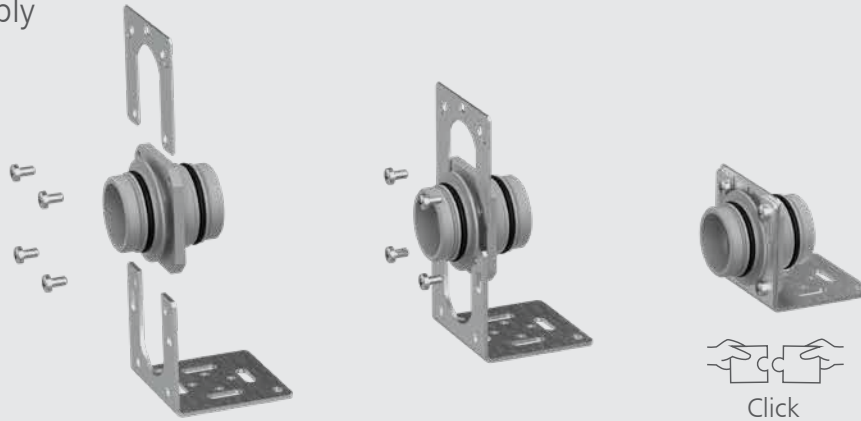

Wall mounting



Carrier rail mounting



Mast mounting

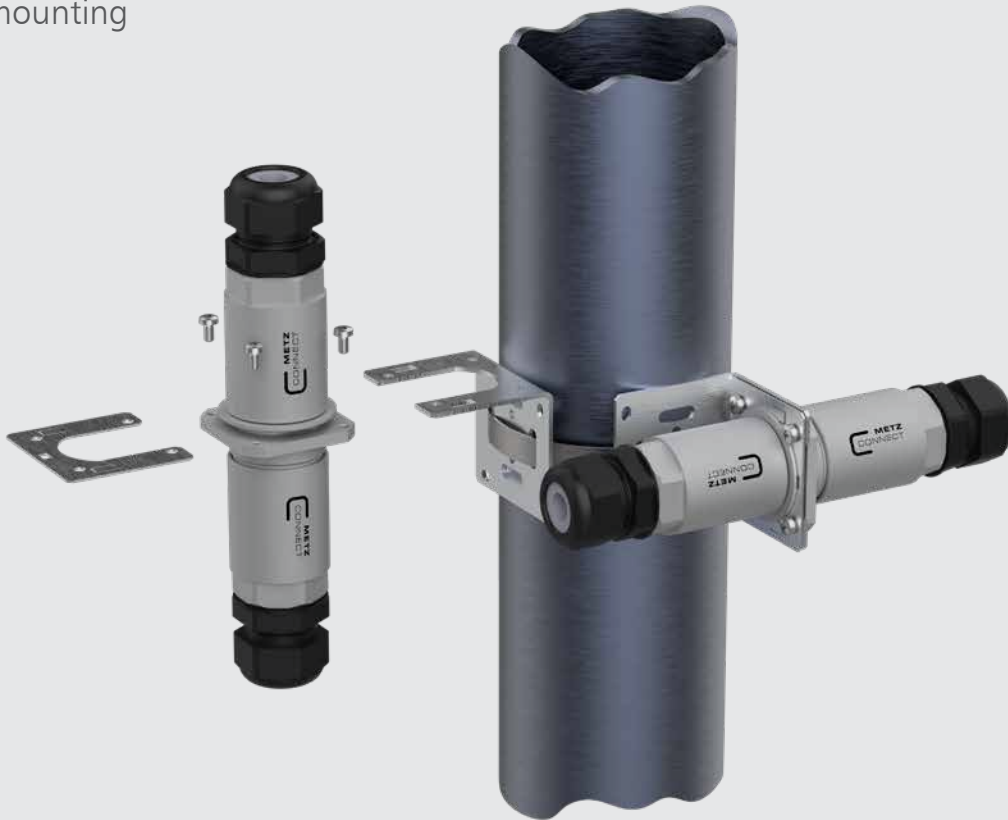

Application example – for wall and housing bushing

Wall mounting





## Application examples

### Moving the active components

e.g. surveillance camera or wireless access point

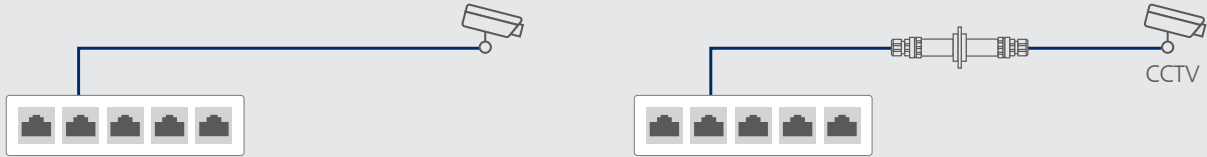

### Cable extension

e.g. cable too short

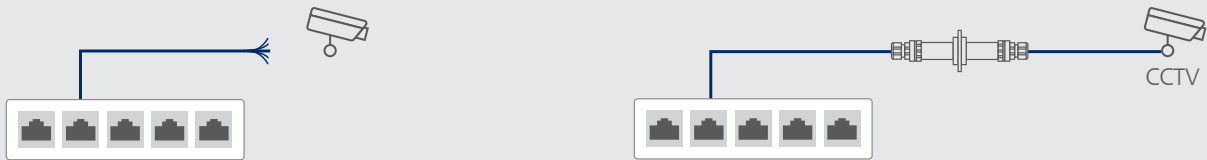

### Repair

e. g. defective cable

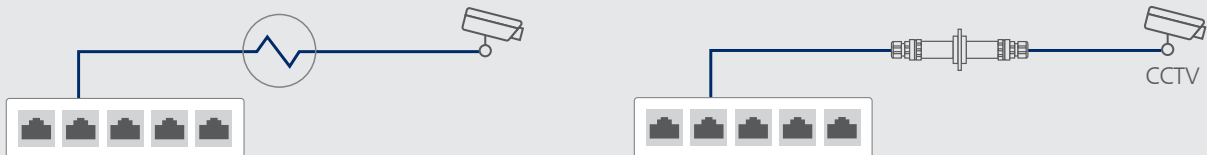

### Reduction of the cable diameter

e. g. too rigid, fixed cable

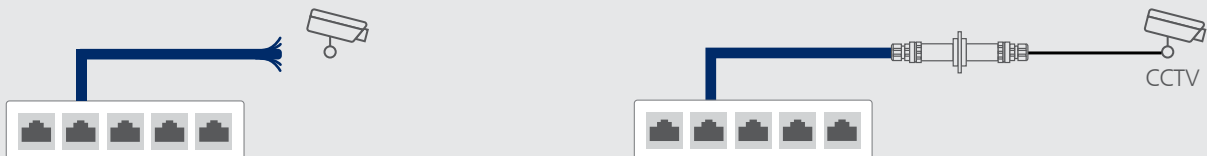





## Notes on the protection of patch cables

The MCO IP69k protective housing for outdoor applications can be used to protect numerous interfaces as well as patch cable connections. Since RJ45 plugs cannot be passed

through the seals included in the scope of delivery due to their dimensions, a remedy must be found.

To ensure IP69k protection, it is recommended to disconnect one side of the patch cable.

To be able to maintain the IP69k protection, ideally one plug side of the patch cable should be disconnected and replaced by a field-terminable plug, such as our C6<sub>A</sub> RJ45 field plug pro

(130E405032-E), so that the installation can then be carried out according to the installation instructions.

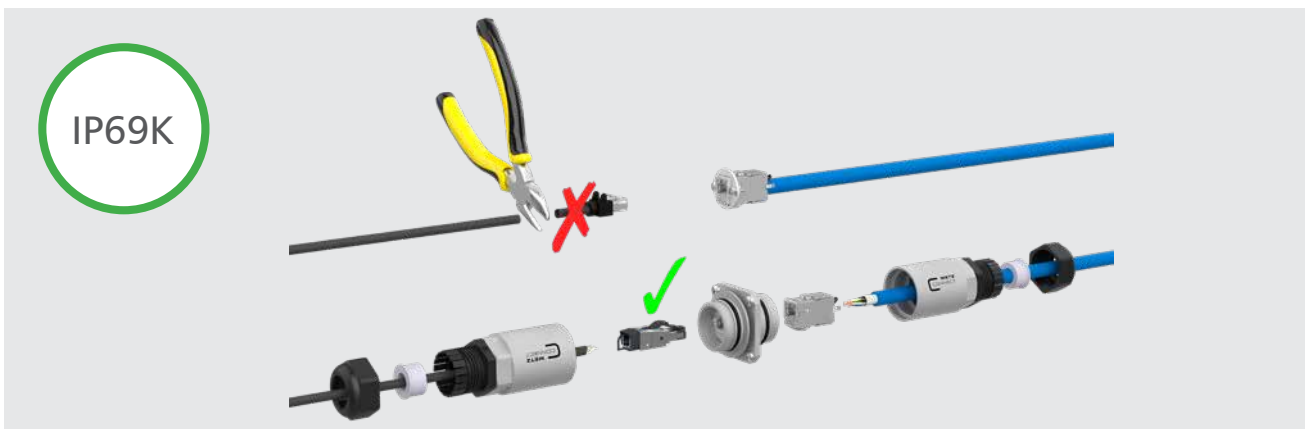

The use of the split seal reduces the degree of protection to IP66 from IP69k.

Alternatively, we offer a split seal for patch cables (895154-I), which can be widened accordingly to allow the RJ45 connector to pass through. Consequently, patch cable connections can be protected without having to disconnect the connected RJ45

plug first. However, it is important to note that the use of the split seal for patch cables (895154-I) reduces the protection class from IP69k to IP66, which is why we only recommend this alternative option to a limited extent.



Furthermore, it should be taken into account that only cables suitable for outdoor installation may be used in outdoor areas, such as our patch cable RJ45 6kV Flex500 Outdoor AWG 24 (13084F3000-E).





**METZ CONNECT GmbH**

Im Tal 2  
78176 Blumberg  
Germany

Phone +49 7702 533-0  
Fax +49 7702 533-189

info@metz-connect.com  
www.metz-connect.com

---

Do you like this solution?  
Please contact Heynen for distribution in BENELUX.

[heynen@heynen.com](mailto:heynen@heyнен.com)

NL tel: +31 (0)485-550909

BE tel: +32 (0)11-600909

LUX tel: +352(0)26-910781