

# GPON Xpert

Multi-Layer GPON Analyzer and OLT Emulator



Complete unbiased GPON analysis

Continuous real-time analysis and event triggering

Multi-layer analysis including TC, OMCI, upper layers and TR-069

OLT emulation with predefined and user-defined tests, including playback

## Multi-Layer GPON Analyzer

GPON Xpert is a unique multi-layer protocol analyzer for GPON products. Specifically designed for R&D, laboratory and field application engineers, GPON Xpert is a modular tool that helps operators and vendors accelerate time-to-market by cutting significant time from development, testing, troubleshooting and deployment of GPON solutions.

## OLT Emulator

GPON Xpert can serve as an OLT Emulator for testing an ONU/ONT on a stand-alone basis, using predefined tests or user-defined ones. The OLT Emulator combined with the GPON analyzer and the built-in traffic generator provides an end-to-end ONU testing solution, which simultaneously generates commands and data, analyzes the ONU response, provides Pass/Fail indications for the tested steps and reports any non-compliance it detects.

## Independent Multi-Layer Analysis

As an independent and unbiased testing platform, GPON Xpert is built without using any GPON chipset. Using its unique multi-layer probing capability, it lays out a comprehensive picture of the protocols and traffic running through the PON. It analyzes and displays the Transmission Convergence (TC) and OMCI Management layers as well as the upper layers, including Ethernet, PPP, PPPoE, IPv4/IPv6, TCP, UDP, DHCP, IGMP, HTTP, RTP and TR-069.

## Flexible Connection Options

GPON Xpert can be connected either at the OLT side or at the ONU side, allowing testing of the whole PON as well as focusing on a selected ONU.

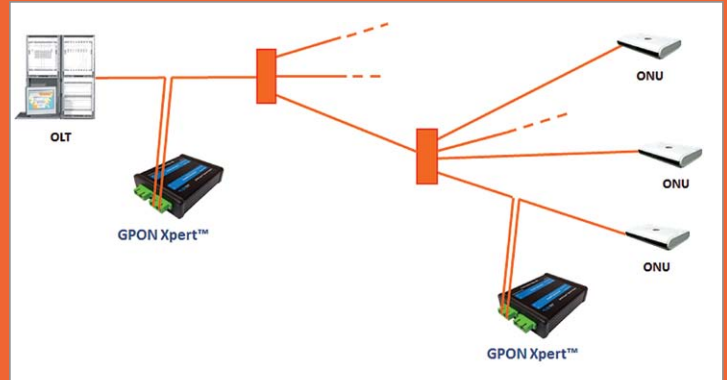

## Compatibility with GPON Tracer™

GPON Xpert is compatible with TraceSpan's GPON Tracer, a unique battery-powered handheld testing device for on-site troubleshooting. It can analyze files recorded with GPON Tracer, thus allowing detailed troubleshooting and deep analysis of network issues.

The GPON Xpert Lite version provides a subset of the GPON Xpert analysis capabilities in a laptop-based solution, enabling detailed troubleshooting in the field.



## PLOAM and OMCI Message Playback

The GPON Xpert OLT Emulator can also play back PLOAM and OMCI messages that were captured from an OLT and inject them into the ONU for troubleshooting of interoperability issues when testing the ONU stand-alone.

## Test Automation

The automated ONU test solution runs multiple OLT Emulator tests in a sequence, thus speeding up the testing process, saving time and effort and minimizing human errors.

GPON Xpert also includes a Command Line Interface (CLI), enabling integration into an automated test environment, with a built-in tool for generation of the CLI commands.

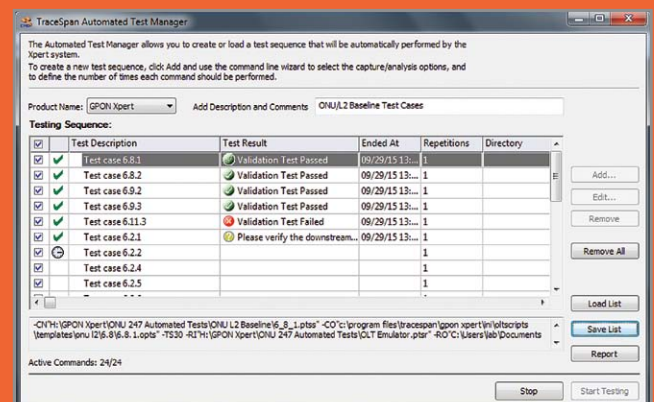

# Intuitive User-Friendly Tool

GPON Xpert simultaneously presents downstream and upstream data and the connection between the data transmitted by the OLT and ONUs. It also features a rich array of intuitive displays, graphs and tables for testing and troubleshooting of the GPON network elements, including network topology, events, parsed messages, OMCI relations diagrams, VLAN routing analysis, performance monitoring tools and more.

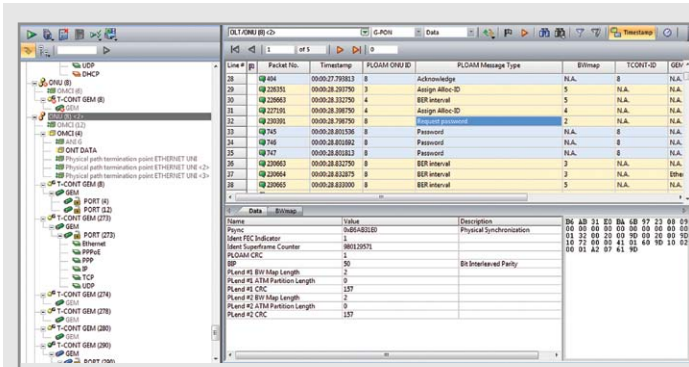

**Information View**  
Topology Tree, TC/OMCI/Upper Layer Data, Signaling and Events

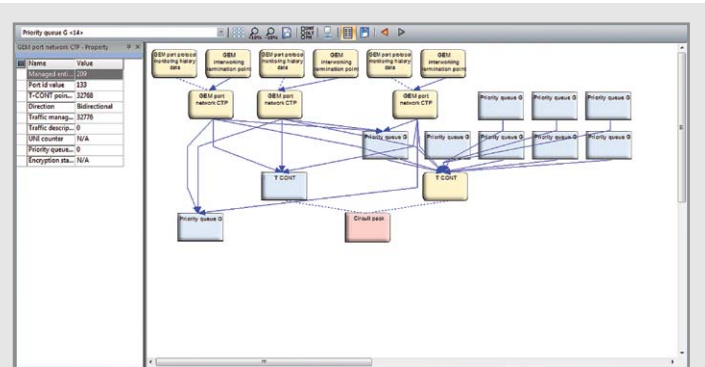

**OMCI Analysis**  
Managed Entities and Relations Diagram

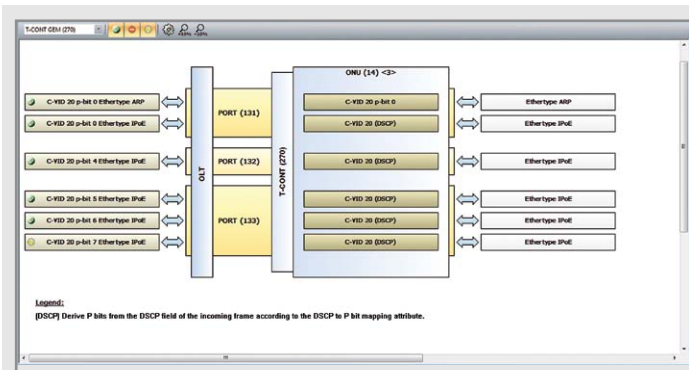

**VLAN Routing Analysis**  
VLAN Tagging and Traffic Routing to GEM Ports by VLANs, P-bits or Ethertype

Name	Status	Type	Failed if occurred	Details
Mapping traffic into GEM Ports based on VID & p-bit values in the case of...	Event	Yes		
ONU 1 - CONT GEM PORT: Ethernet - Packet Error control	Event	Yes		
ONU Command processing error	Event	Yes		
MSB Update	Predefined	No		
Ethernet Tagging One Tag	Predefined	No		Equal to 390
VID	Predefined	No		Equal to 1
Fail	Predefined	No		Equal to 1220
Ethernet Tagging One Tag	Predefined	No		Equal to 1220
VID	Predefined	No		Equal to 390
Sent through port	Predefined	No		Equal to 2
Sent through T-COAT	Predefined	No		Equal to 1220
Ethernet Tagging One Tag	Predefined	No		Equal to 1220
Sequential	Predefined	No		
ONU/DGM Message Serial number ONDP	Message	No		
OLT/PLDAM Message/Ranging Time	Message	No		
OLT/PLDAM Message/Configure Port ID	Message	No		
ONU/DGM Message/Acknowledge	Message	No		

**Validation Testing**  
Pass/Fail Results for Predefined and User-defined Test Procedures

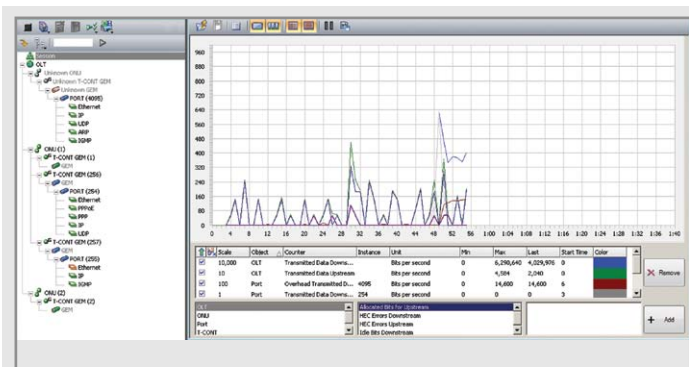

**Performance Monitoring**  
Data Rates, Bandwidth Allocations (DBA) and Error Rates

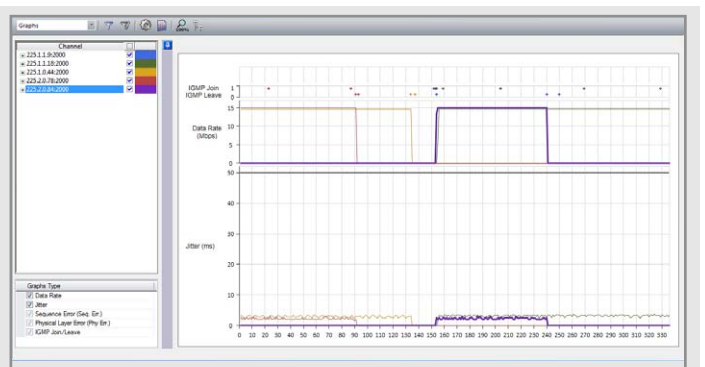

**IPTV Analysis**  
Graphs and Tables of IPTV Channels QoE Parameters and IGMP Messages

## Standard Compliance Verification and Interoperability Testing

Ensuring proper operation of GPON network element enables equipment manufacturers and chipset vendors to build high-quality products and shorten time-to-market. It also provides flexibility to operators in providing reliable high-bandwidth services to their customers.

GPON Xpert clearly indicates abnormal behaviors and deviations from the relevant standards, thus verifying standard compliance and interoperability between different vendors' OLTs and ONUs.

## Extensive Reporting and Exporting Capabilities

GPON Xpert supports the generation of detailed analysis reports in a user-friendly HTML format. Selected information can also be exported for further analysis in various formats, such as PCAP and CSV.

## Specifications

Standards Compatibility	ITU-T G.984.1, G.984.2, G.984.3 – GPON Specifications ITU-T G.984.4, G.988 – ONU Management and Control Interface (OMCI) BBF TR-156 – GPON in the Access Network BBF ATP-247/TP-247 – ONU Conformance Test Plan
EMC Standards	FCC 47CFR Part 15, Subpart B, Class A EN 61326-1, Class A
Safety Standards	IEC 61010-1, EN 61010-1

### For More Information

**Visit:** [www.tracespan.com](http://www.tracespan.com)

**Contact us:** [info@tracespan.com](mailto:info@tracespan.com)

Copyright © 2021 TraceSpan™ Communications Ltd. All rights reserved.  
Product design and specifications are subject to change without notice.