

heynen 

Heynen works for innovators

heynen 

U



# 38 Series Photo-MOSFET Relay

- Features: High Voltage Photo MOSFET Relay, switching up to 600V DC or Peak AC
- THT, SMD or SOP; High I/O Isolation
- Tested in accordance with AEC-Q101, UL listed, RoHS Compliance
- Applications: Automatic Test Equipment, Battery Management Systems, I/O Modules, Telephone Equipment
- Markets: Automotive, Telecommunication, Test & Measurement, Security

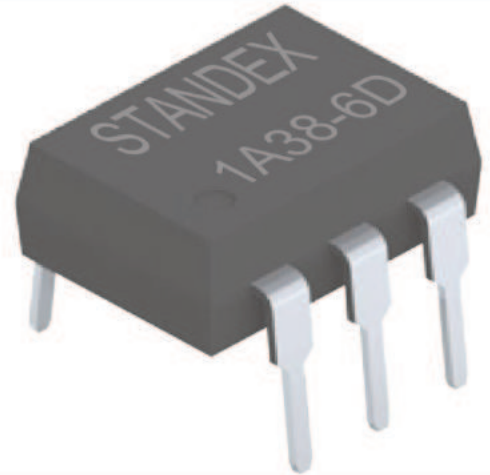

Part Description: **SMP-XA38-XXX-X**

Number of Poles	Contact Form	Series Number	Number of Pins	Mounting Type	Package Style	Special Features
1, 2	A	38	4, 6, 8	D, S, P	Tube, Reel	Nil, Q, R

See page 7 for Glossary

Maximum Ratings @ Ambient Temperature = 25°C								
Parameters	Symbol	Value					Units	Condition
		1A38-4P	2A38-8P	1A38-4D, S	2A38-8D, S	1A38-6D, S		
<b>INPUT SPECIFICATIONS</b>								
Continuous LED Current	$I_F$	50	50	50	50	50	mA	-
Peak LED Current	$I_{FP}$	500	500	500	500	500	mA	f=100Hz, 1% Duty Cycle
LED Reverse Voltage	$V_R$	5	5	5	5	5	V	-
Input Power Dissipation	$P_{IN}$	75	75	75	75	75	mW	-
<b>OUTPUT SPECIFICATIONS</b>								
Load Voltage	$V_L$	600	600	600	600	600	DC or Peak AC	-
Load Current	$I_L$	70	60	80	70	80	mA	-
Peak Load Current	$I_{PEAK}$	200	200	200	200	200	mA	1 ms, 1 shot
Output Power Dissipation	$P_{OUT}$	300	450	450	600	450	mW	-
<b>GENERAL SPECIFICATIONS</b>								
Total Power Dissipation	$P_T$	350	500	500	650	500	mW	-
I/O Breakdown Voltage	$V_{I/O}$	1500	1500	3750	3750	3750	$V_{RMS}$	-
I/O Breakdown Voltage	$V_{I/O}$	3750	3750	5000	5000	5000	$V_{RMS}$	Suffix R
Operating Temperature	$T_{OPR}$	-40/+85	-40/+85	-40/+85	-40/+85	-40/+85	°C	-
Operating Temperature	$T_{OPR}$	-40/+105	-40/+105	-40/+105	-40/+105	-40/+105	°C	Suffix Q
Storage Temperature	$T_{STG}$	-40/+100	-40/+100	-40/+100	-40/+100	-40/+100	°C	-



# 38 Series Photo-MOSFET Relay

## Maximum Ratings @ Ambient Temperature = 25°C

Parameters	Symbol	Min	Typ	Max	Units	Condition
<b>INPUT SPECIFICATIONS</b>						
LED Forward Voltage	$V_F$	1.0	1.17	1.5	V	$I_F = 10\text{mA}$
Operation LED Current	$I_{F,ON}$	-	1.0	3.0	mA	-
Recovery LED Voltage	$V_{F,OFF}$	0.5	1.0	-	V	-
<b>OUTPUT SPECIFICATIONS</b>						
On Resistance: Drain to Drain	$R_{ON}$	-	40	60	$\Omega$	$I_F = 5\text{mA}, I_L = \text{Rating (within 1 sec.)}$
Off-State Leakage Current	$I_{LEAK}$	-	-	1.0	$\mu\text{A}$	$V_L = 200\text{V}$
Output Capacitance	$C_{OUT}$	-	47	-	pF	$V_L = 0\text{V}, f = 1\text{MHz}$
<b>TRANSMISSION SPECIFICATIONS</b>						
Turn-On Time	$T_{ON}$	-	0.2	0.5	ms	$I_F = 5\text{mA}, I_L = \text{Rating (for SOP type)}$
Turn-Off Time	$T_{OFF}$	-	0.05	0.2	ms	
Turn-On Time	$T_{ON}$	-	0.1	1.0	ms	$I_F = 10\text{mA}, I_L = \text{Rating (for DIP/SMD type)}$
Turn-Off Time	$T_{OFF}$	-	0.05	0.5	ms	
<b>COUPLED SPECIFICATIONS</b>						
I/O Insulation Resistance	$R_{I/O}$	$10^9$	-	-	$\Omega$	-
I/O Capacitance	$C_{I/O}$	-	1.3	-	pF	$f = 1\text{MHz}$

hcynca

## Photo-MOSFET Relay Dimensions (Tolerances acc. to ISO 2768-mp)

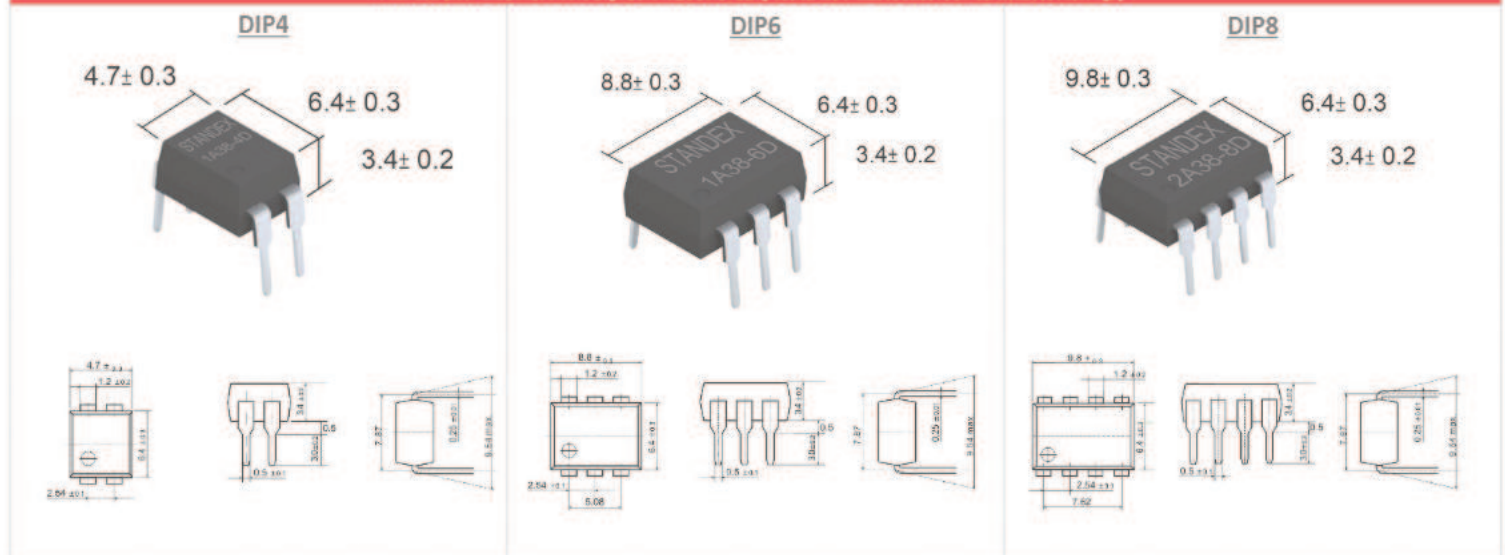

# 38 Series Photo-MOSFET Relay

## Photo-MOSFET Relay Dimensions (Tolerances acc. to ISO 2768-mp)

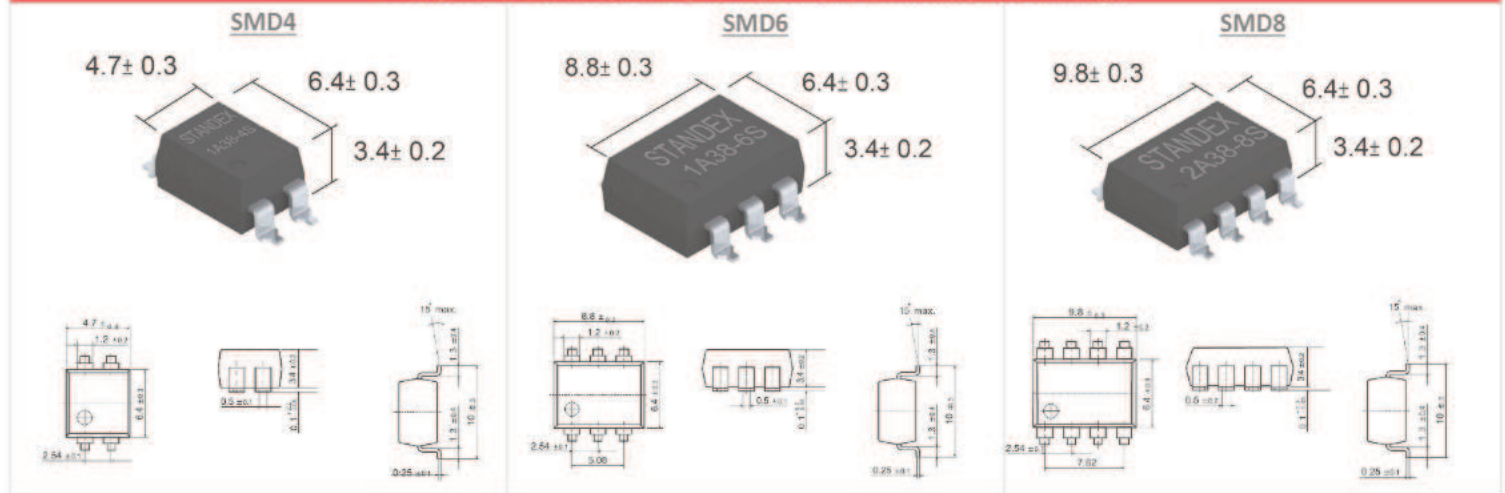

## Photo-MOSFET Relay Dimensions (Tolerances acc. to ISO 2768-mp)

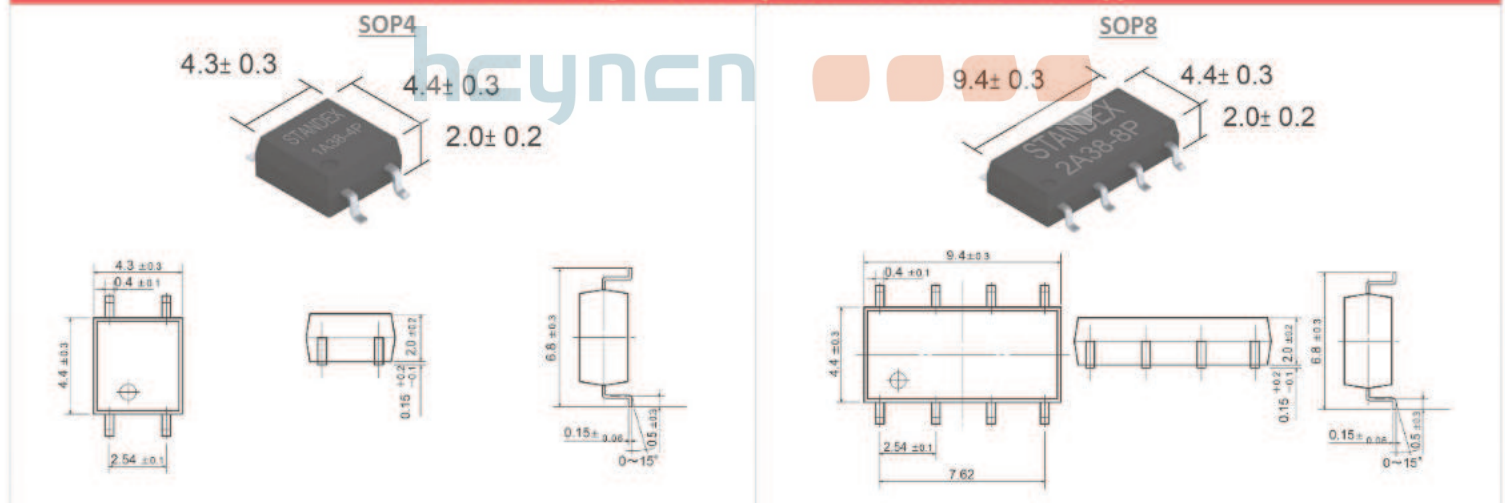

## Photo MOSFET Relay Pin-Out (Top View)

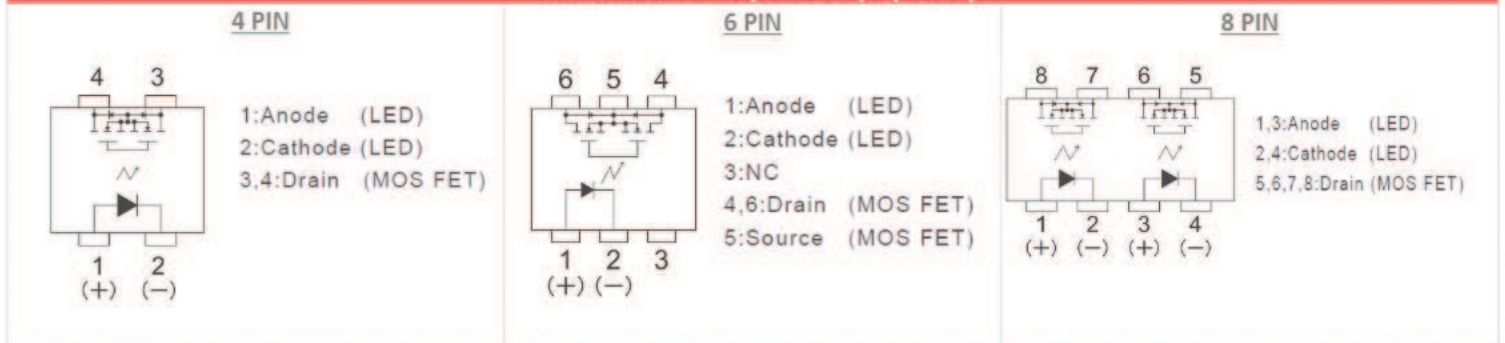

# 38 Series Photo-MOSFET Relay

## Photo MOSFET Relay Recommended PCB Pad Layout (Tolerances acc. to ISO 2768-mp)

DIP4 (Bottom View)

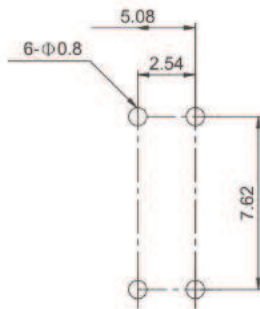

DIP6 (Bottom View)

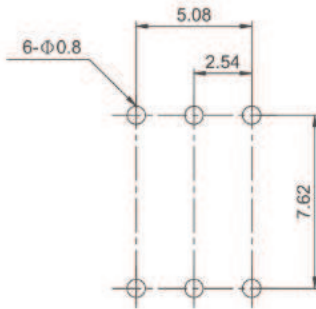

DIP8 (Bottom View)

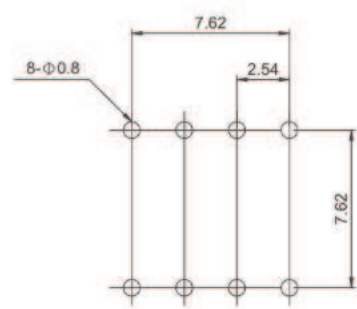

SMD4 (Top View)

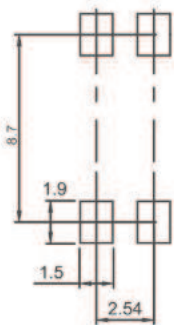

SMD6 (Top View)

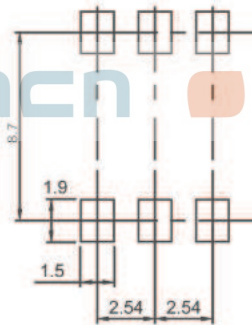

SMD8 (Top View)

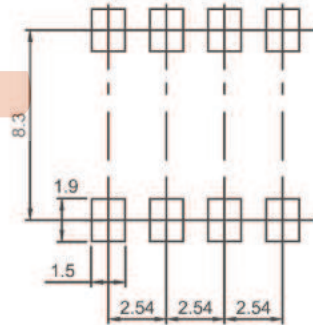

SOP4 (Top View)

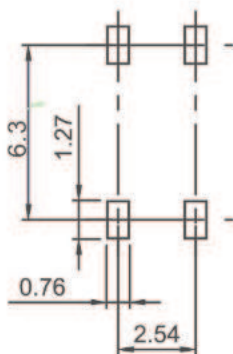

SOP8 (Top View)

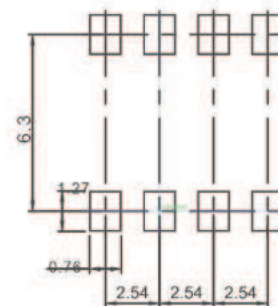

# 38 Series Photo-MOSFET Relay

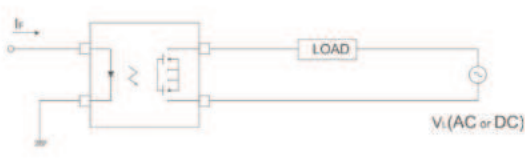
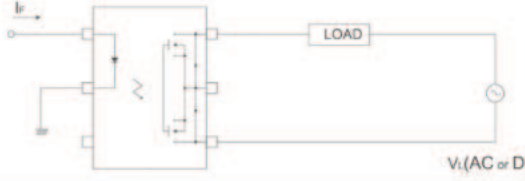
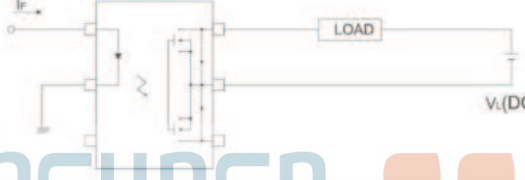
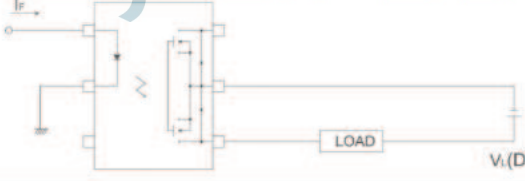
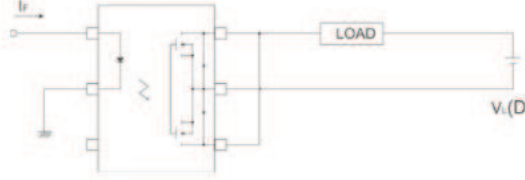
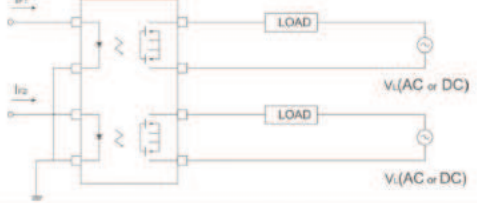
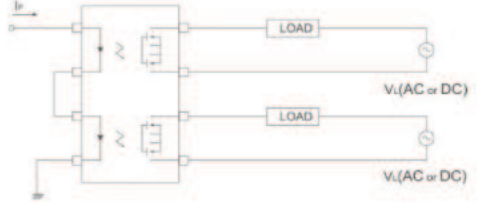
Photo-MOSFET Relay Load Connection Method			
TYPE	LOAD	CONNECTION	FEATURE
4-PIN	AC OR DC		Control bi-directional signal
6-PIN	AC OR DC		Control bi-directional signal
	DC		On-Resistance is 1/2 of connection 1
			2-Make-contacts (Source Common)
	DC		On-Resistance is 1/2 of connection 2
8-PIN	AC OR DC		2 inputs and 2 outputs
			1 input and 2 outputs

# 38 Series Photo-MOSFET Relay

## Photo MOSFET Relay Reference Data

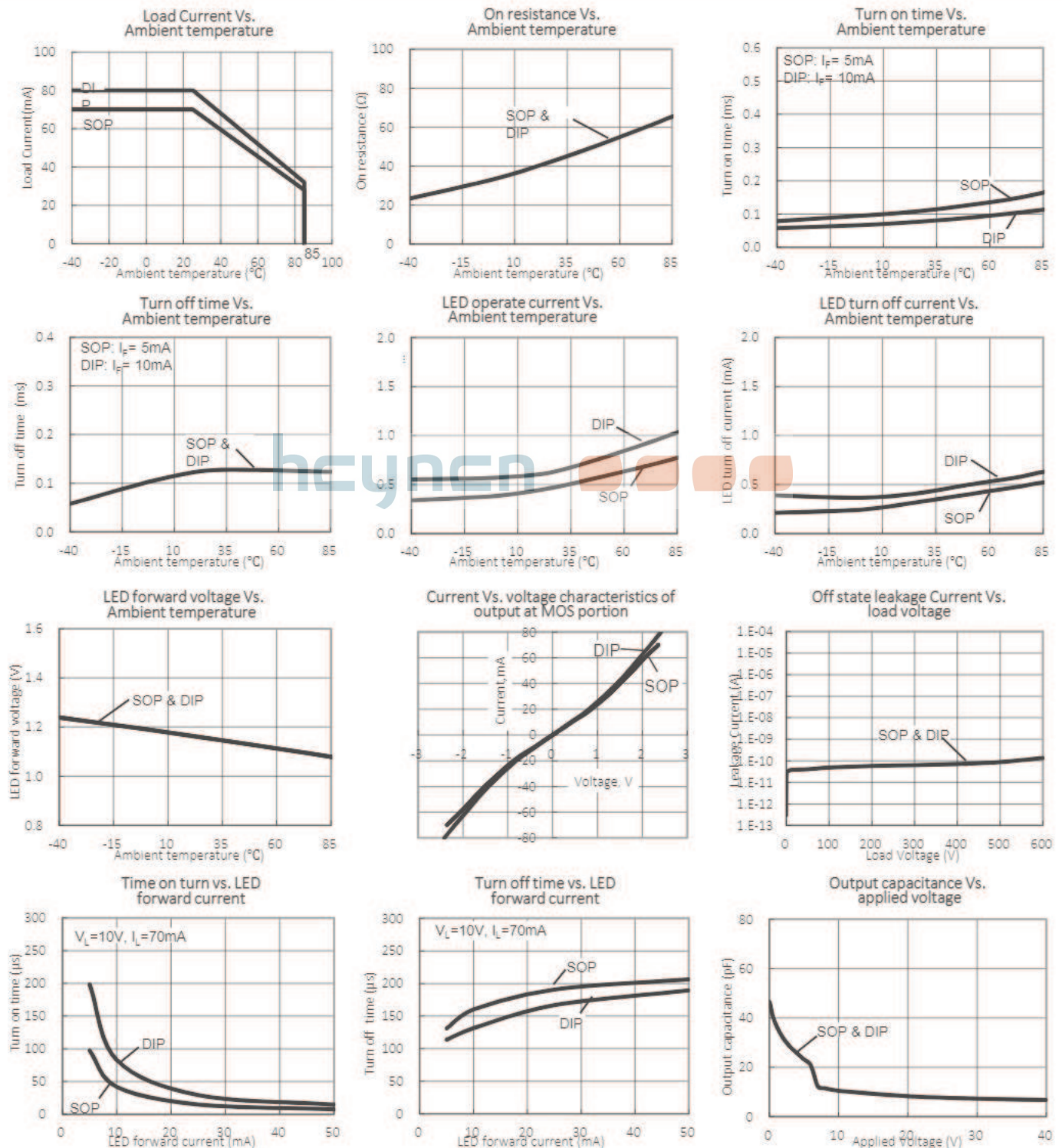

# 38 Series Photo-MOSFET Relay



## Photo MOSFET Relay Reference Data for "Q" High Temperature Version

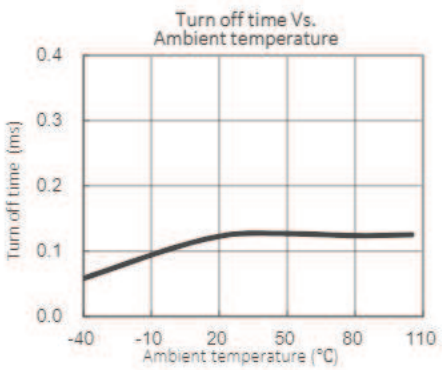
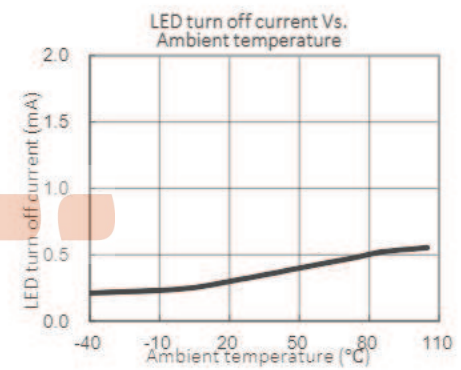
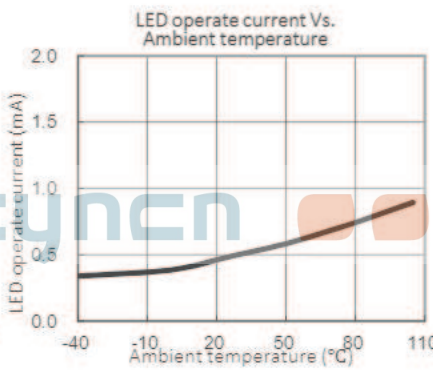
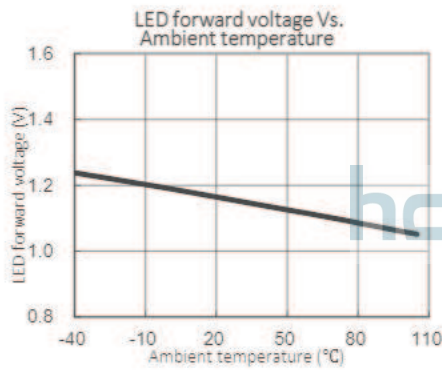
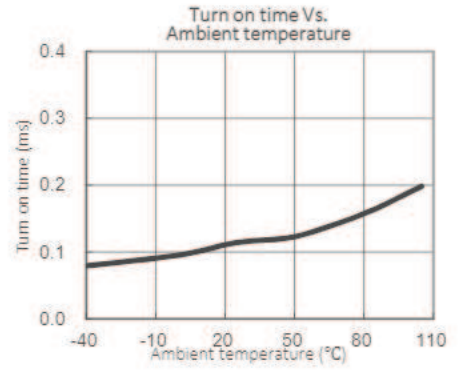
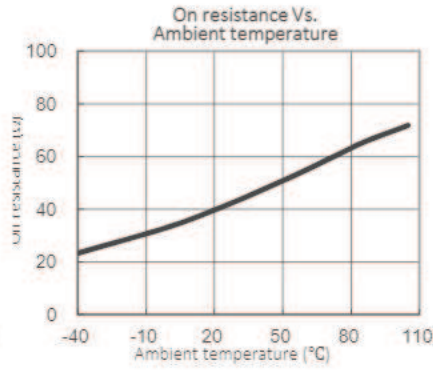
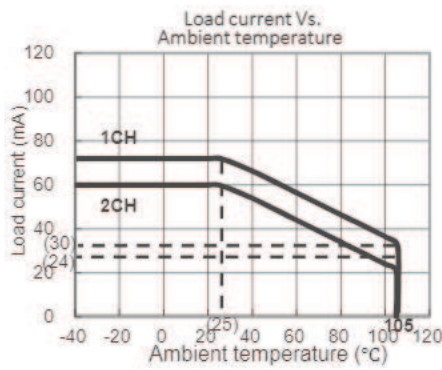



# 38 Series Photo-MOSFET Relay

## Photo MOSFET Relay Tape & Reel Packaging (1,000 pcs per reel)

### SMD4

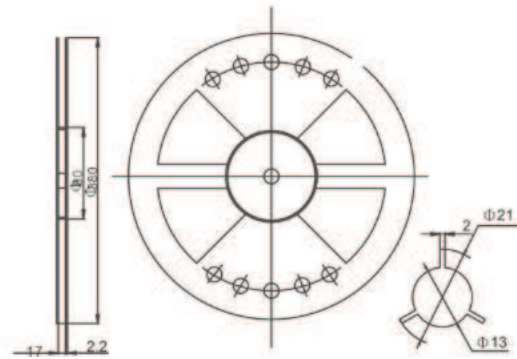
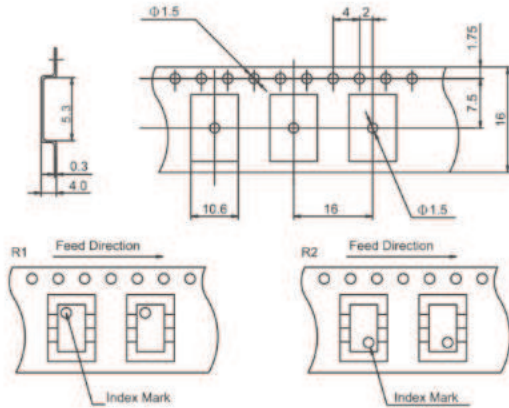

### SMD6

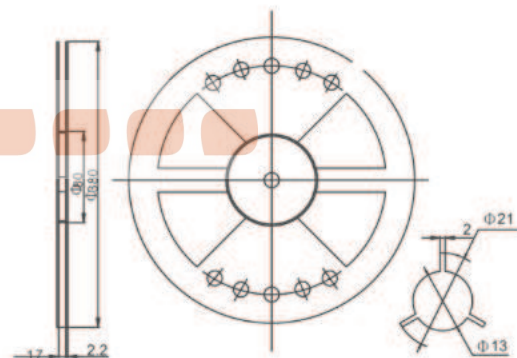
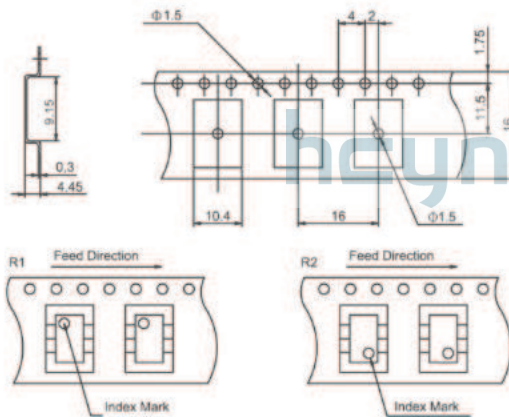

### SMD8

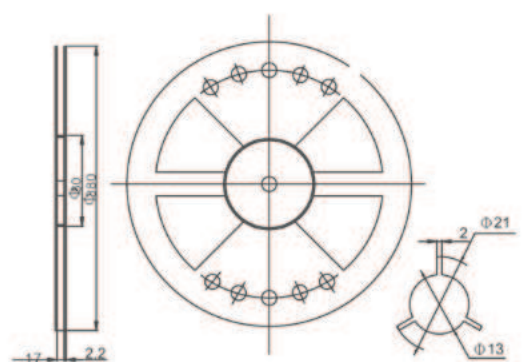
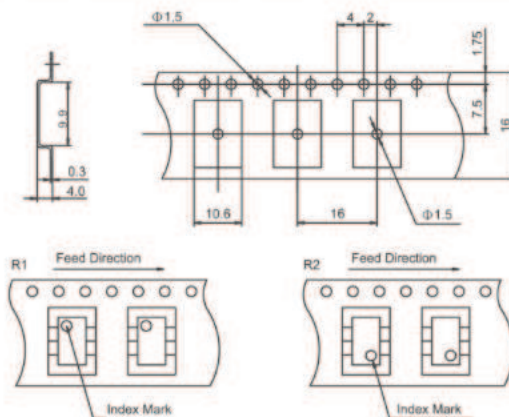

# 38 Series Photo-MOSFET Relay

## Photo MOSFET Relay Tape & Reel Packaging (1,000 pcs per reel)

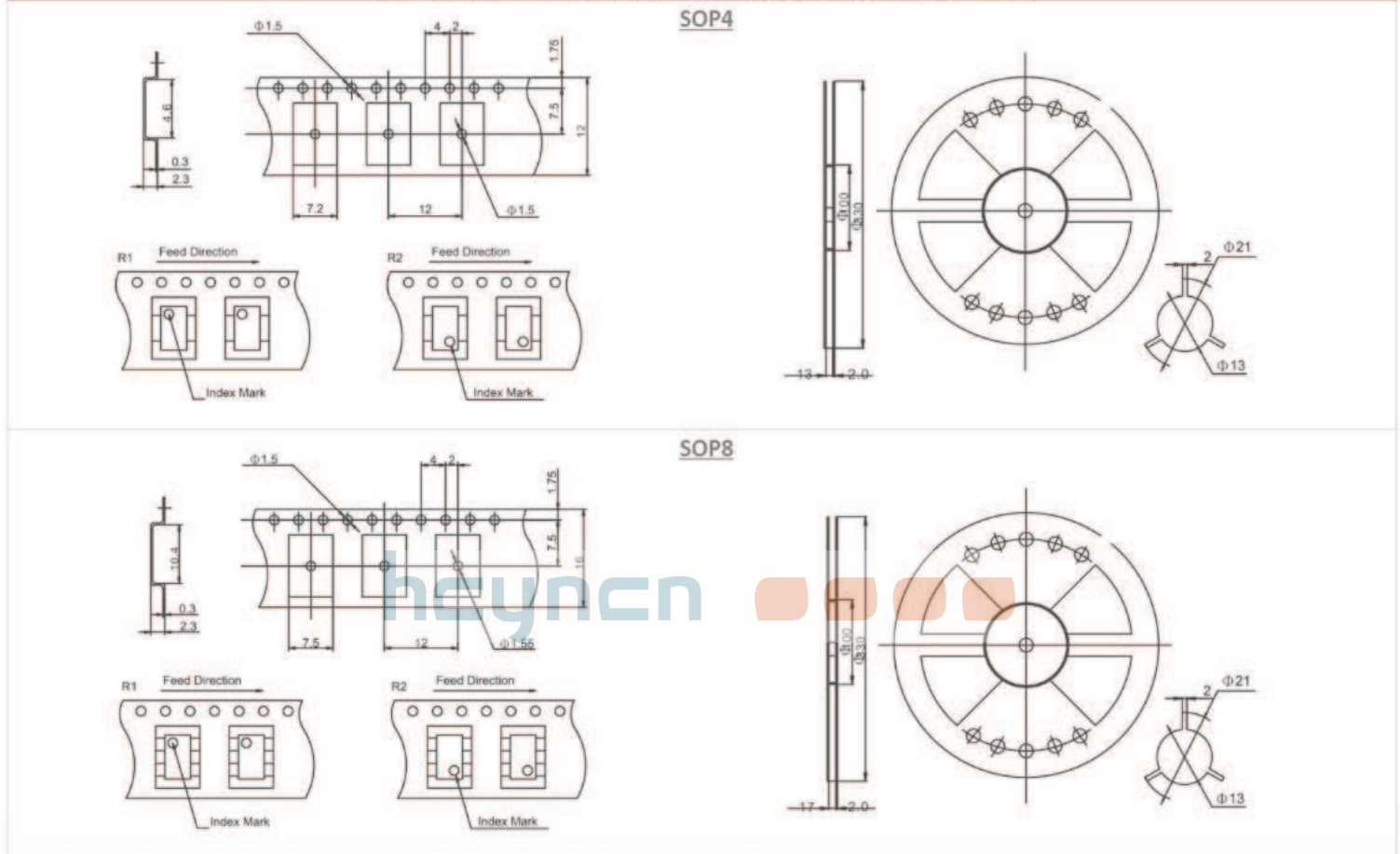

### Glossary Options

D	DIP (Dual-In-Line Package)
S	SMD (Surface Mount Design)
P	SOP (Small-Outline Package)
Q	AEC-Q101 / High Temperature
R	Reinforced Isolation

**Please note:** All technical specifications in this series datasheet refer to the standard product range. Modifications in the sense of technical progress are reserved. For general information only. For more specific information, please consult the product datasheet, available upon request.

This series datasheet could contain technical inaccuracies or typographical errors. Changes are periodically made to the information herein. These changes will be incorporated in future revisions.

For deviating values, latest specifications and product details, please contact your nearest sales office.

h y n  
h c c

h c  
heyne 

h y

h c

h y

h y

h c

h c

**Heynen werkt voor vernieuwers**

Hierbij een document van Heynen. Deze producten worden door ons exclusief vertegenwoordigd in de Benelux. Voor een demo of offerte kan u rechtstreeks contact opnemen met onze account managers.

**Heynen travaille pour des innovateurs**

Voici un document de Heynen. Nous représentons ces produits exclusivement pour le Bénélux. N'hésitez surtout pas de demander votre personne de contacte pour un démo ou une proposition de prix.

**Heynen works for Innovators**

Here is a document from Heynen. We represent these products exclusively for the Benelux. Please contact our account managers for a quotation or demonstration.

**Heynen Leistung für Neuerer**

Anliegend eine Dokumentation von Heynen. Wir haben die exklusive Vertretung dieser Produkte für den Benelux-Raum. Bitte nehmen Sie Kontakt auf mit unserem Kundenbetreuer, falls Sie ein Angebot oder eine Vorführung benötigen.

[heynen@heynen.com](mailto:heynen@heynen.com) • [www.heynen.com](http://www.heynen.com) • 