

heynen 

Heynen works for innovators



U

h y n h
h c h
h o h
h y h
h n h
h y h
h n h
h y h
h n h
h y h
h n h



ISA-PLAN® // PRECISION RESISTORS

FMS // Size 2512

PRELIMINARY VERSION

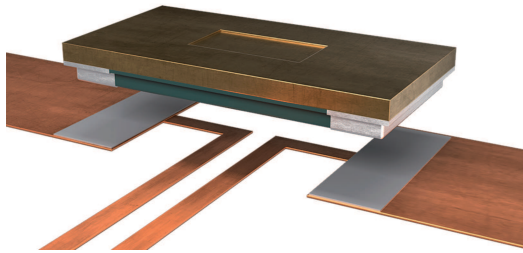

Features

- Power rating up to 4 W at 70°C (1.5 mOhm)
- Constant current up to 50 A (1.5 mOhm)
- Standard pad size (2512)
- High pulse power rating
- Excellent long-term stability
- Mounting: Reflow- and IR-soldering
- AEC-Q200 qualification in preparation
- RoHS 2011/65/EU compliant



Applications

- Current sensor for power hybrid applications
- Control systems for the automotive market
- Power modules
- Frequency converters
- Switch mode power supplies

Preliminary technical data

Resistance values	mOhm	1.5 / 2 / 3 / 4 / 5 / 6
Tolerance	%	1 / 5
Temperature coefficient (20-60 °C)	ppm/K	<50
Applicable temperature range	°C	-65 to +170
Power rating	W	up to 4
Dielectric withstanding voltage	V AC/DC	200
Inductance	nH	<3
Stability (at rated power) deviation after 2000h, T _K = Terminal temperature		< 0.5 % (TK=80 °C) < 1.0 % (TK=110 °C)

Type	Value [mΩ]	R _{thi} [K/W]	TCR [ppm/K]	P _{70 °C}	P _{110 °C}
FMS-Z-R0015*	1.5	20	<50	4	3
FMS-M-R002*	2	25	<50	3.5	2
FMS-M-R003*	3	40	<50	2.5	1.5
FMS-V-R004*	4	50	<50	2	1
FMS-V-R005*	5	55	<50	1.5	1
FMS-V-R006*	6	67	<50	1.5	1

* values in preparation

Ordering code

FMS - M - R003 - 1.0

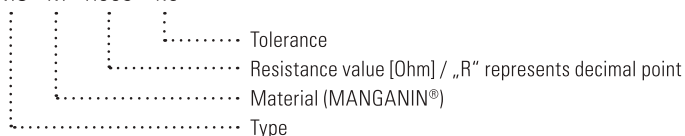



FMS // Size 2512

Recommended solder profile

Reflow- and IR-soldering

Temperature	°C	260	255	217
Time	sec	peak	40	90

Tape and reel information

Specification	DIN EN 60286-3		
Tape width	mm	12	
Reel size	inch	13	
Parts per reel	pcs	9000	
Packaging weight net	g	539	

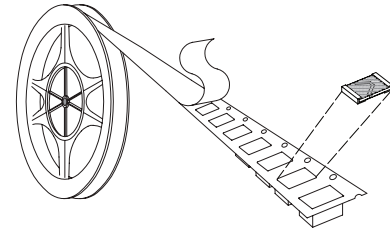

Information

Product status	under development
Sample availability	B-samples
Qualification release acc. AEC-Q200	Q2/2020
Mass production availability	Q4/2020

Mechanical dimensions and pcb-layout proposal (Reflow-soldering) [mm] / Drawing Z-YL-256

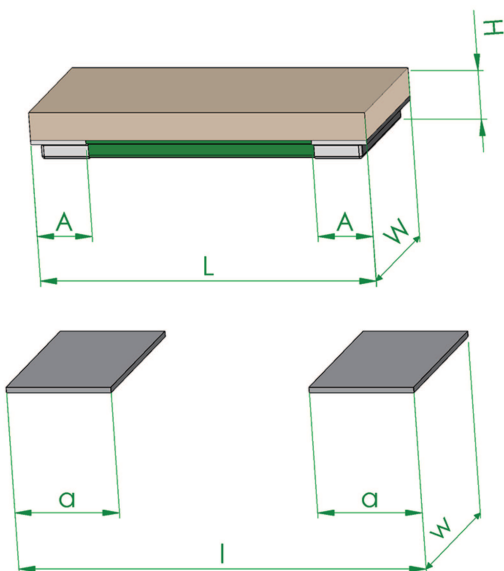

type:	L	W	H	A
FMS	6.35 ±0.3	3.05 ±0.2	0.4 ±0.2	0.9 ±0.2

solder pad type:	l	w	a
FMS	7.5	3.6	1.55



FMS // Size 2512

Temperature dependence of the electrical resistance of MANGANIN® resistors

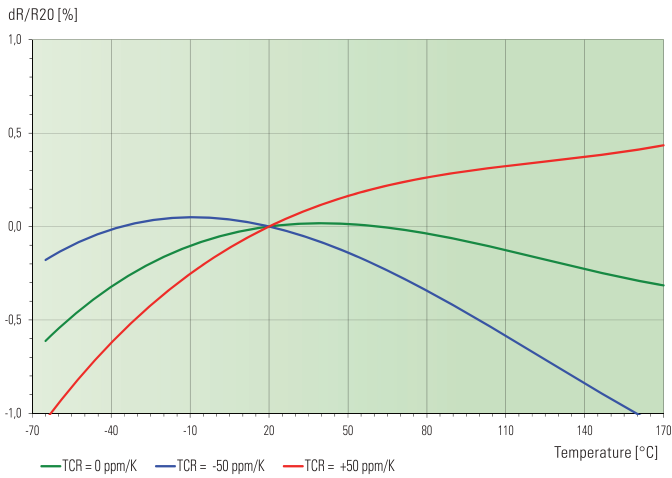

Temperature dependence of the electrical resistance of ZERANIN® resistors

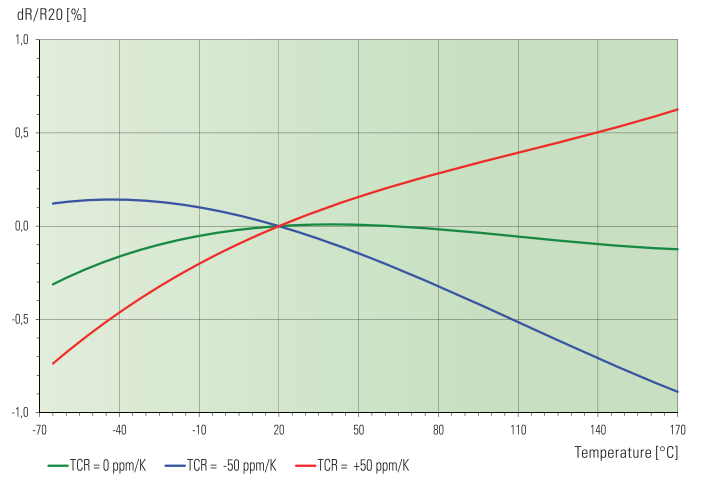

Temperature dependence of the electrical resistance of NOVENTIN® resistors

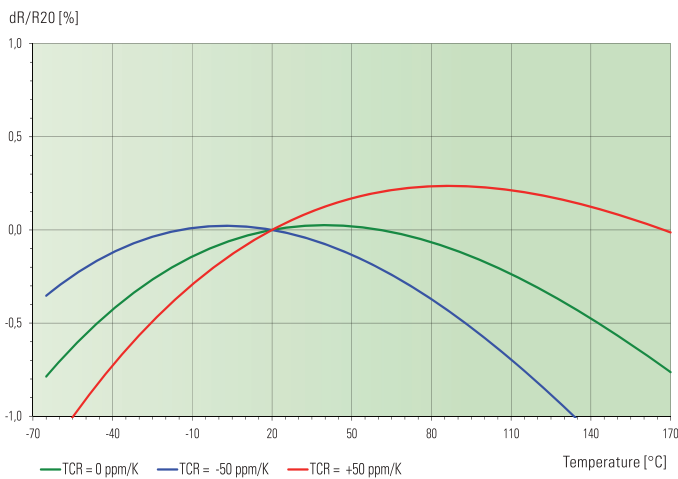

Power derating curve

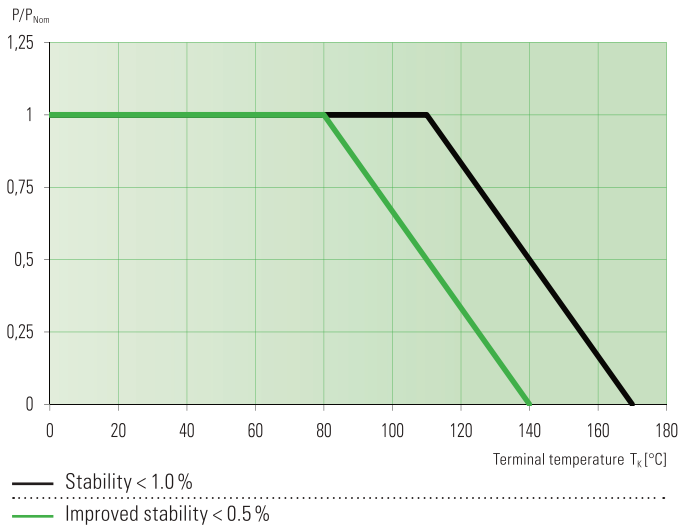



FMS // Size 2512

Maximum pulse energy respectively pulse power for permanent operation

FMS-Z-R0015, FMS-M-R003, FMS-V-R006
Maximum pulse energy / power continuous operation ($T_K = 110\text{ °C}$)

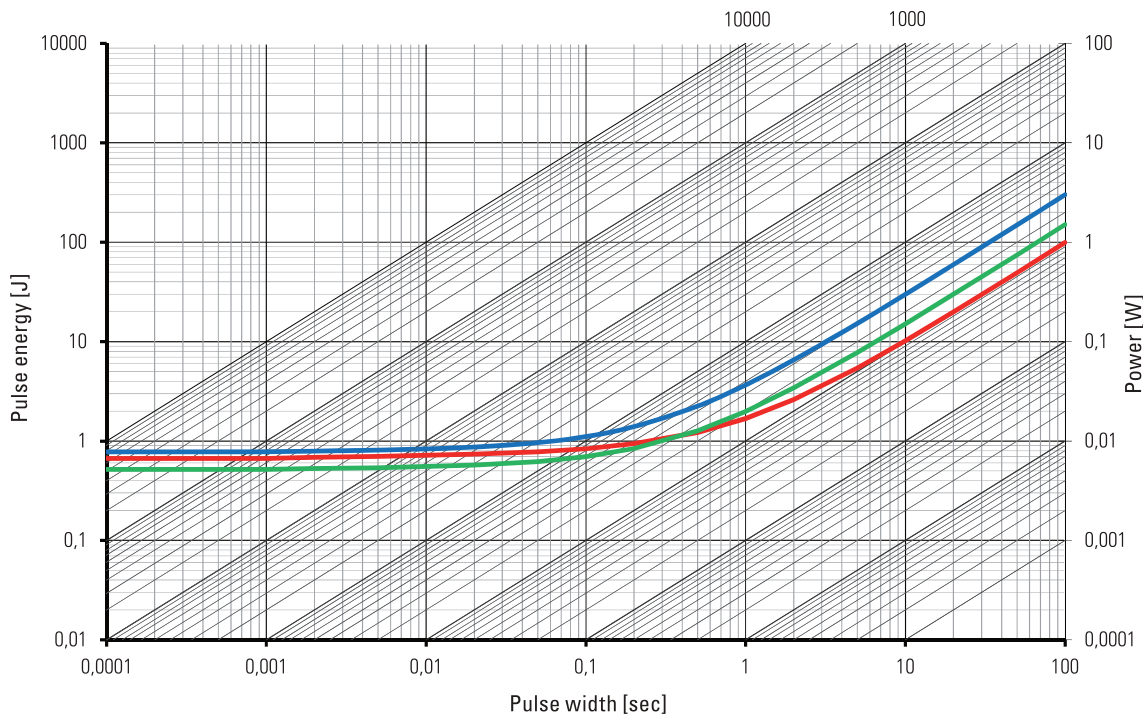

Specification

Parameters	Test conditions	Specified values
Temperature Cycling	2000 cycles (-55 °C to +150 °C)	in preparation
Low Temperature Storage	-65 °C for 250 h	
Moisture Resistance	MIL-STD-202 method 106	
Mechanical Shock	100 g, 6 ms half sine	
Vibration, High Frequency	10 g, 10-2000 Hz, 24 h each axis	
Operational Life	2000 h, T_K max at rated power	
High Temperature Exposure	2000 h / 170 °C	
Bias Humidity	+85 °C, 85 r.F., 1000 h, powered	

Disclaimer // All products, product specifications and data are subject to change without notice.

The product specifications do not expand or otherwise modify Isabellenhütte's terms and conditions of sale, including but not limited to, the warranty expressed therein. Isabellenhütte makes no warranty, representation or guarantee other than as set forth in its terms and conditions of sale.

Information provided in datasheets and/or specifications may vary from actual results in different applications. Any statements made by Isabellenhütte regarding the suitability of products for certain types of applications are based on its knowledge of typical requirements that are often placed on its products. It is the customer's responsibility to validate that a particular product with the properties described in the product specification is suitable for use in the application intended.

No license, express or implied, or otherwise, to any intellectual property rights is granted by this document.

Any and all liability arising out of the application or use of any product shall be as set forth in Isabellenhütte's terms and conditions of sale.



h y n

hc c

c

h y

c

h y

h y

c

hc

Heynen werkt voor vernieuwers

Hierbij een document van Heynen. Deze producten worden door ons exclusief vertegenwoordigd in de Benelux. Voor een demo of offerte kan u rechtstreeks contact opnemen met onze account managers.

Heynen travaille pour des innovateurs

Voici un document de Heynen. Nous représentons ces produits exclusivement pour le Bénélux. N'hésitez surtout pas de demander votre personne de contacte pour un démo ou une proposition de prix.

Heynen works for Innovators

Here is a document from Heynen. We represent these products exclusively for the Benelux. Please contact our account managers for a quotation or demonstration.

Heynen Leistung für Neuerer

Anliegend eine Dokumentation von Heynen. Wir haben die exklusive Vertretung dieser Produkte für den Benelux-Raum. Bitte nehmen Sie Kontakt auf mit unserem Kundenbetreuer, falls Sie ein Angebot oder eine Vorführung benötigen.

heynen@heynen.com • www.heynen.com • [Linked in](#)