

MINIATURE HIGH VOLTAGE 1kVDC REED RELAYS

DESCRIPTION

Standex Electronics introduces a brand new MHV series of miniature high voltage reed relays. This surface mount (SMD) series body measures only L17.2mm x W10.5mm x H8.5mm. Making the MHV series the smallest in the entire high voltage offering.

These Reed Relays are designed to switch system voltages levels up to 1kVDC and withstand even higher breakdown voltages with a minimum of 3kVDC, while ensuring low leakage currents. The MHV combines the excellent electrical and thermal properties in combination with the compact design.

The MHV's efficient power consumption coupled with its high voltage, low leakage current, and high isolation properties make this series ideal in any device containing a battery management system. MHV relays are particularly suitable where isolation measurements between low and high voltage circuits are frequently monitored. Typical applications include electric vehicles, photovoltaic systems, test and measurement, and medical equipment.

FEATURES

- Smallest High Voltage Relay - up to 1,000 VDC Switching Voltage
- Breakdown Voltage 3 kVDC across the open switch
- 5 kV Dielectric Strength Coil/Contact
- Effective power consumption
- Meets creepage and clearance distance requirements acc. to IEC 60664-1, IEC 60255-27 and ISO 6469-3
- Designed to meet AEC-Q200, UL approved
- In compliance with RoHS and REACH

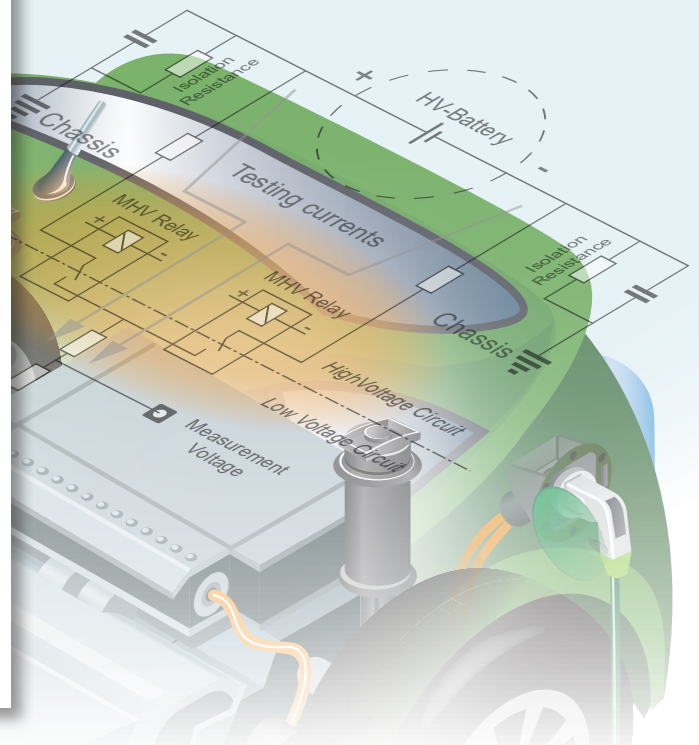
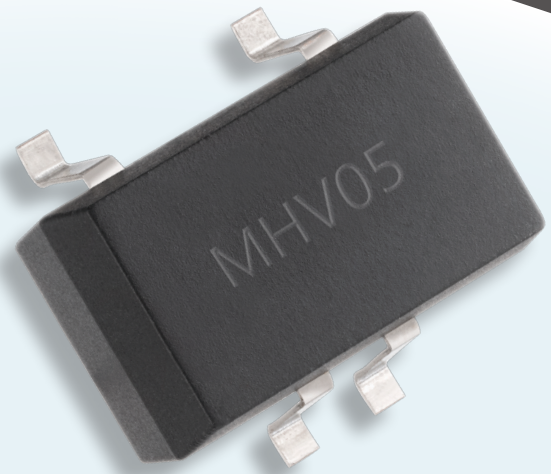

www.standexelectronics.com

Americas: +1.866.782.6339
info@standexelectronics.com

APAC: +86.21.37606000
salesasia@standexelectronics.com

EMEA: +49.7731.8399.0
salesemea@standexelectronics.com

MINIATURE HIGH VOLTAGE 1kVDC REED RELAYS

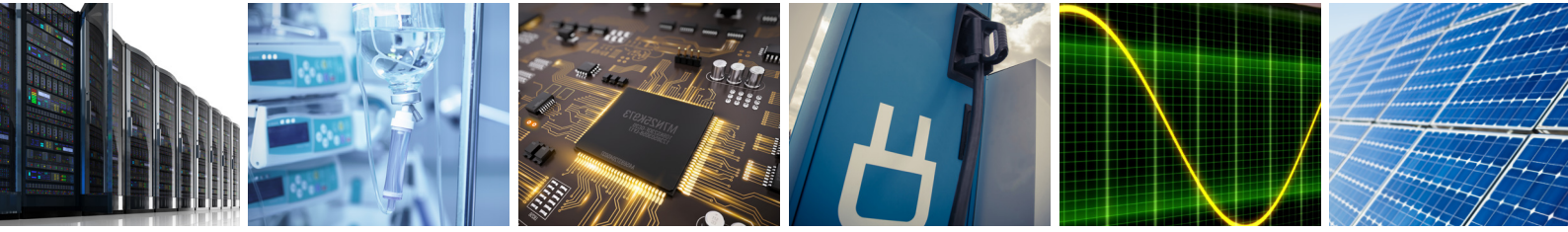

MHV SERIES

OPERATING CHARACTERISTICS

Coil Voltage:	5 VDC	Switching Current Max. :	0.7A
Coil Resistance Typ.:	140 Ω	Carry Current (100% Duty Cycle) Max.:	1.25A
Contact Form:	1A	Insulation Resistance Min.:	10 ¹¹ Ω
Rated Power Max.:	180mW	Dielectric Strength (Coil to Contact):	5kVDC
Switching Voltage Max.:	1kVDC	Operating Temperature Max.:	-40 to 105°C
Breakdown Voltage Min.:	3kVDC	Storage Temperature Max.:	-40 to 125°C

Please note: All technical specifications on this flyer refer to the standard product range. Modifications in the sense of technical progress are reserved. For general information only. For more specific information, please consult the product datasheet, available upon request.

DIMENSIONS MM [INCH]

Tolerances acc. to DIN ISO 2768-m

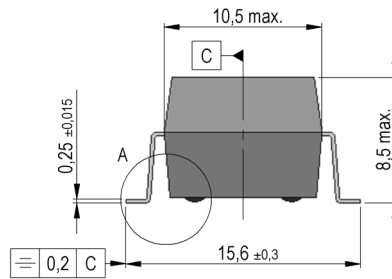
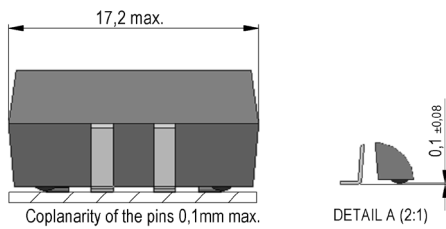

ISOMETRIC

Scale 1:1

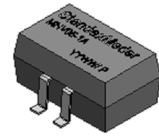

RECOMMENDED PAD LAYOUT (Top View)

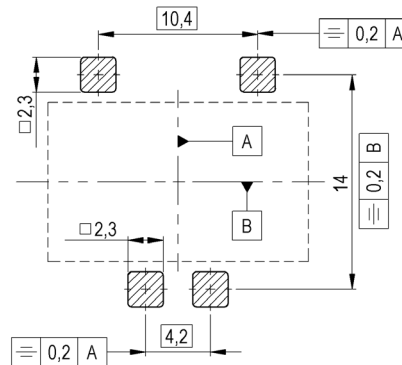
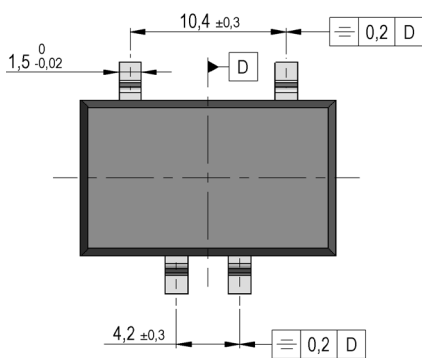

SCHEMATIC

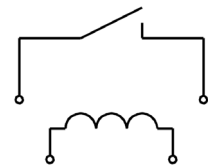

MARKING Acc. to EN60062 / Factory code



Automotive // Electric Vehicles // Battery Management Systems // Photovoltaic Inverters
Isolation Measurement // Medical Equipment // Automated Test Equipment // High Density Matrix

www.standexelectronics.com

Americas: +1.866.782.6339
info@standexelectronics.com

APAC: +86.21.37606000
salesasia@standexelectronics.com

EMEA: +49.7731.8399.0
salesemea@standexelectronics.com

