



MEASUREMENT AND CONTROL

# LINE

Integral Energy Management System

# EMSi

## Integral Energy Management System

**It has never been easier:**

**Continuous management, maintenance and integrated control**

The **Line** system devices are designed to monitor and control different types of installations, both those where the energy consumption has to be managed and those where the devices installed in the network have to be controlled.

Its modular architecture offers a solution that can be fully adapted to any type of need by connecting different modules through its internal **Bus-Line** communications system.

The result is the ability to create a compact and custom device that can adapt to any requirement, present or future.

The new **Line** system lets you monitor and record any value you wish to manage (electricity, water, gas consumption, temperatures, flow rates, pressures, etc.) and control any system integrated into the installation (lighting, HVAC, pumps, etc.).





# Line Series

Complete modular system for energy management



## Line-EDS

Datalogger with built-in webserver

- 
- Line-EDS-Cloud
- Line-EDS-PS
- Line-EDS-PSS
- Line-EDS-PSS-PRO



## Line-CVM

Power analyzer

- 
- Line-CVM-D32



## Line-M-4IO

Input/output modules

- 
- Line-M-4IO-T
- Line-M-4IO-R
- Line-M-4IO-RV
- Line-M-4IO-A



## Line-M-20I

Module with 20 digital inputs

- 
- Line-M-20I



## Line-M-3G

Modem for 3G communications



## Line-TCPRS1

RS-485 to Ethernet and Wi-Fi converter



## Line-M-EXT-PS

Power supply



### Total flexibility for any installation

The Line devices which are part of the integral Energy Management System (EMS) offers multiple combinations, allowing you to create a solution custom-made for each installation.

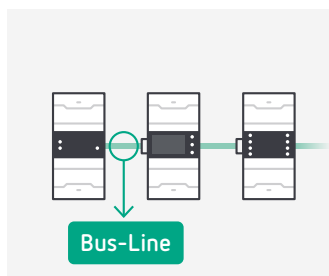

### It has never been easier.

The modular design of the system allows any associated Line device to be installed quickly, securely and automatically thanks to its integrated Bus-Line communications.



# Two models, four types of management.

## Designed for complete control of installations.

With the Line system devices, you decide how to manage any installation. Manage them using IoT cloud platforms or with our **integral Energy Management System**, working locally or remotely.

### TWO MODELS



#### Line-EDS-Cloud

LINE-EDS-CLOUD

Cloud data monitoring

Can be used to send data directly to the cloud, registering and integrating them into the major Big Data platforms, so you can easily manage them using simple Dashboards, directly from the internet.



#### Line-EDS-PS

LINE-EDS-PS / -PSS / -PSS-PRO

Data monitoring

Integrated control of installations

Maintenance

It allows to manage and register the information of a installation on a single device using an integrated web server, without the need to install a PC, as it incorporates the powerful energy management tool **PowerStudio**, by CIRCUTOR.

### FOUR TYPES OF MANAGEMENT

1

Monitoring system using **Line-EDS-Cloud**

2

Monitoring and control system using **Line-EDS-PS**

3





Monitoring and control system using **Line-EDS + PowerStudio**

4

Monitoring and control system using **PowerStudio**

## Line-EDS-Cloud

Remotely monitor your installation using IoT platforms

-  On-line monitoring
-  Data tables
-  Graphs
-  Alarms
-  Generic Modbus driver

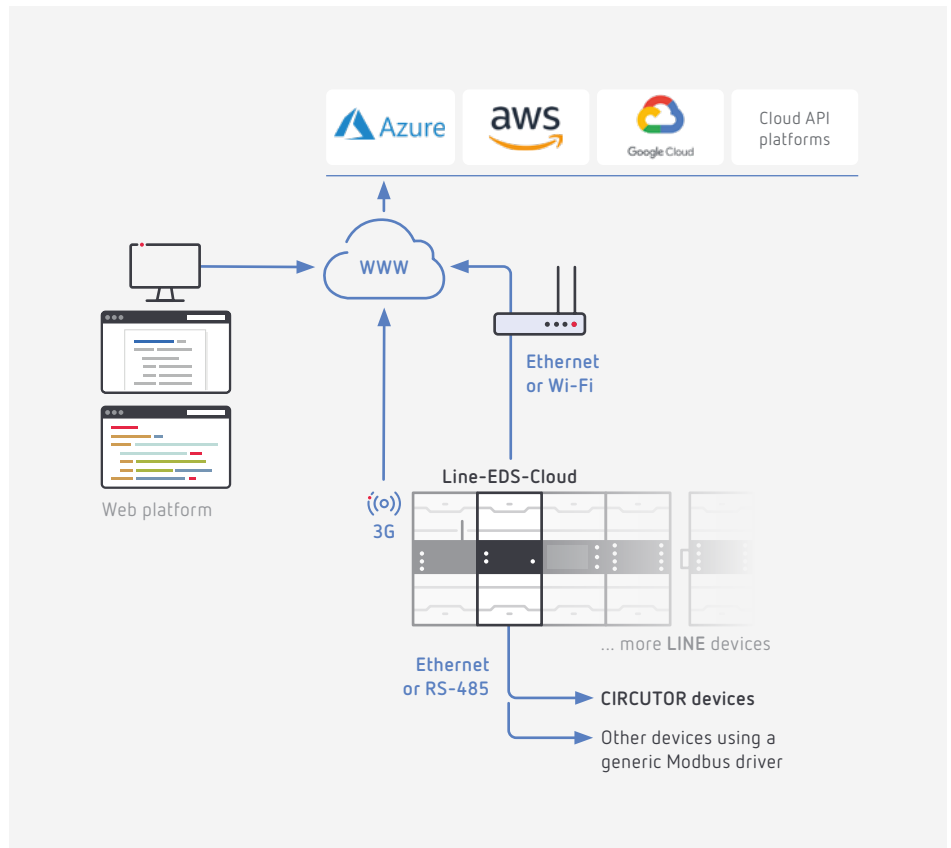

### System features:

- > Compatible with the major IoT platforms for Big Data analysis.
- > Distributed system, allowing data from multiple installations to be centralized in the same system.
- > Connect from anywhere with internet access.
- > Does not require installing and maintaining a local server.
- > No programming specialists required.

### Examples of IoT platforms

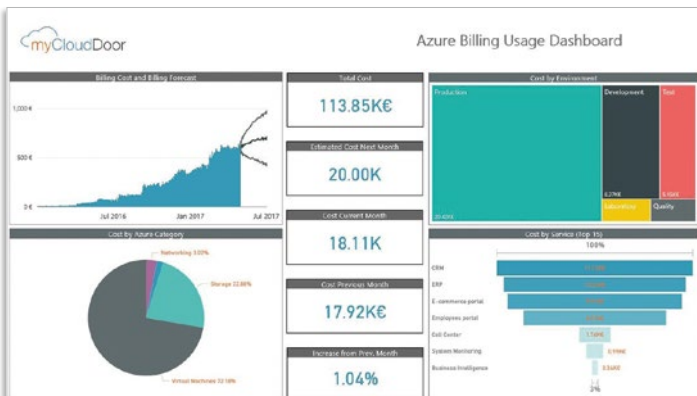

Azure platform









AWS platform



- Line-EDS-PS
- Line-EDS-PSS
- Line-EDS-PSS-PRO

Access the EMSi software from anywhere and with any web browser

-  online monitoring
-  Alarms
-  Billing simulation\*
-  Graphs
-  Data tables
-  SCADA screens\*
-  Generic Modbus driver

\* Available with Line-EDS-PSS and Line-EDS-PSS-PRO models

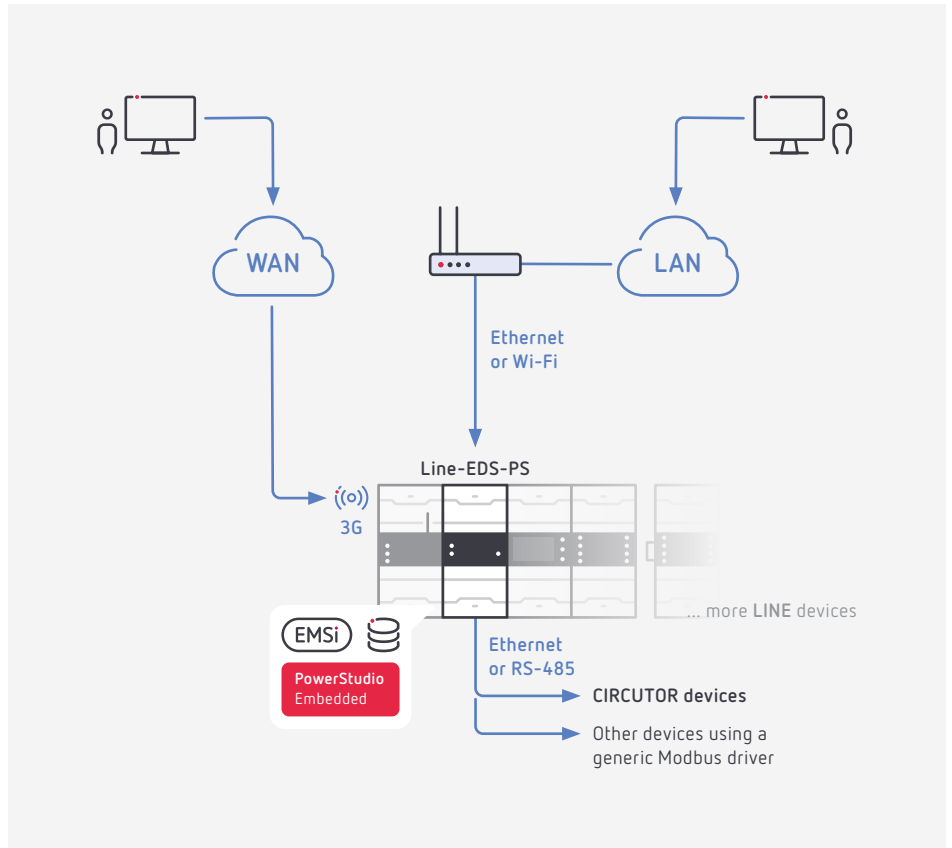

## EMSi (Integral Energy Management System)

Manage consumption + Installation control + Maintenance

### System features:

- > Line-EDS-PS incorporates EMSi software for the integral management of installations.
- > Access EMSi from any web browser, whether in local or remote mode.
- > Does not require installing and maintaining a local server.
- > Generic Modbus driver to add any device on the market.
- > Internal memory for data analysis and traceability using graphs and tables.
- > Energy consumption management.
- > Automatic control of installations.
- > Alarms and billing simulation for proper maintenance.

### Accessible via Webserver or PowerStudio



**□ All your consumption at a glance**

Record and manage the measurements of all your energy and consumption variables with the Line devices. Easily add any meter that uses the Modbus protocol. Use the **Line-CVM-D32** power analyzer to record electricity consumption, and the **Line-M** input and output modules to record other consumption using pulses. Group consumption into different hourly rates, manage your installation as per the ISO 50001 standard and monitor all the information directly on a SCADA display.

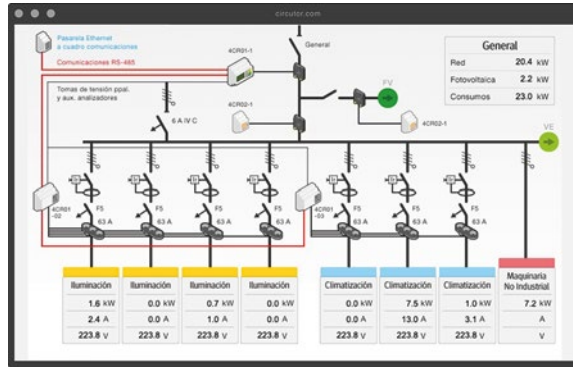

**□ Control and automate your installation**

Line-EDS-PS can integrate any Modbus RTU and/or Modbus TCP device, enabling both the reading and management of any device with this protocol (HVAC machines, variable speed and frequency drives, compressors, level pumps, etc.).

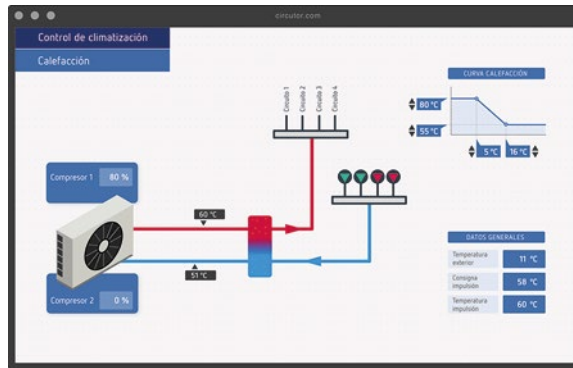

**□ Stay on top of everything that is happening in your installation**

With Line-EDS-PSS and Line-EDS-PSS-Pro it is possible to program the automatic sending, via mail electronic, of invoice simulations, reports or alarms to be at all times informed of the behaviour of the facility.

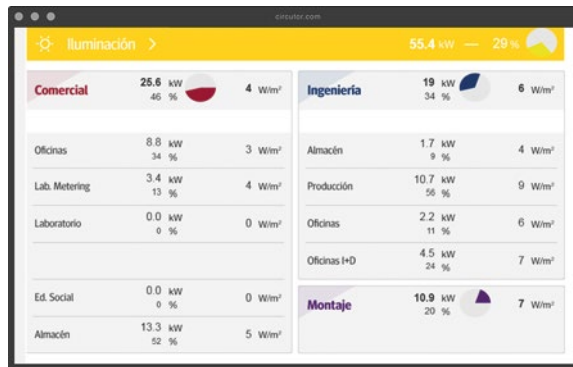







Line-EDS-PS

Line-EDS-PSS

Line-EDS-PSS-PRO

Access **PowerStudio** from anywhere, through your own server or using any web browser.

-  On-line monitoring
-  Alarms
-  Billing simulation\*
-  Graphs
-  Data tables
-  SCADA screens\*
-  Generic Modbus driver

\* Available with Line-EDS-PSS and Line-EDS-PSS-PRO models

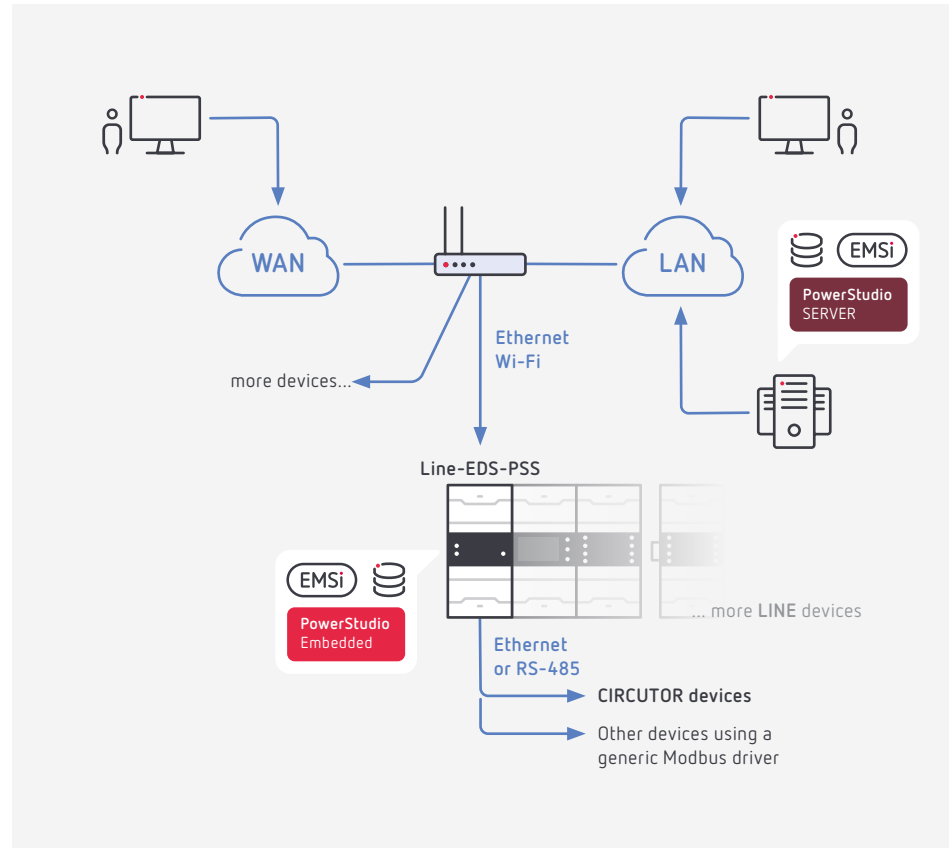

### System features:

- › Manage your installation from your own server (**PowerStudio Server**).
- › Add as many devices as you want with **PowerStudio Server**.
- › Access **EMSi** from any web browser, whether in local or remote mode.
- › Redundant database through the installation of **Line-EDS-PS** devices.
- › No limit on memory for data analysis and traceability using graphs and tables.

### + Features of the monitoring and control system using **Line-EDS-PS**

**Efficiency combined with energy control.**  
Three versions of the **PowerStudio** energy management software .







### **PowerStudio**

- › Monitor variables in real time
- › Data base creation
- › Display the recorded data graphically and in tables
- › XML Server Export data to .txt and .csv files



## Line-CVM + Line-M

Create a custom solution with **Line** devices and manage it with **PowerStudio Server**.

-  On-line monitoring
-  Alarms
-  Billing simulation\*
-  Graphs
-  Data tables
-  SCADA screens\*
-  Generic Modbus driver\*

\*Depending on version of PowerStudio

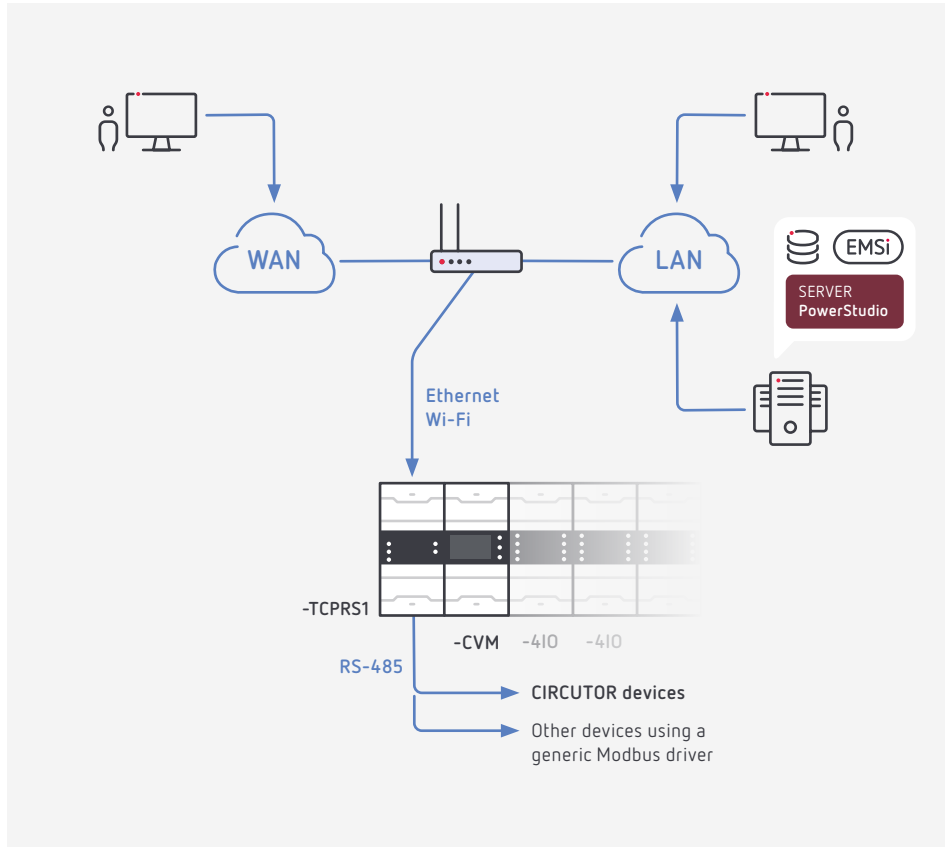

### System features:

- > Create your **Line** solution using as many devices as you need, and expand it at any time.
- > Manage your installation from your own server (**PowerStudio** software).
- > Access **EMSi** from any web browser, whether in local or remote mode.
- > Add as many devices to your communications network as you want with **PowerStudio**.
- > No limit on memory for data analysis and traceability using graphs and tables.

 **PowerStudio SCADA**

PowerStudio 

- > SCADA screens
- > Reports, invoice simulations and configurable alarms

 **PowerStudio SCADA Deluxe**

PowerStudio SCADA 

- > Generic Modbus driver
- > OPC Client



# Line system devices. It has never been easier.

## BUS-LINE, WITHOUT CABLES

The modular design of the **Line** solution allows any **Line** device to be installed quickly, securely and automatically thanks to its integrated **Bus-Line** communications. No additional set-up is required.

The system is fully expandable, allowing for **Plug & Play** connections of the various modules; digital or analogue inputs/ outputs, power analyzers, datalogger with web server and Ethernet/Wi-Fi or 3G communications.

## Add new devices whenever you need more features

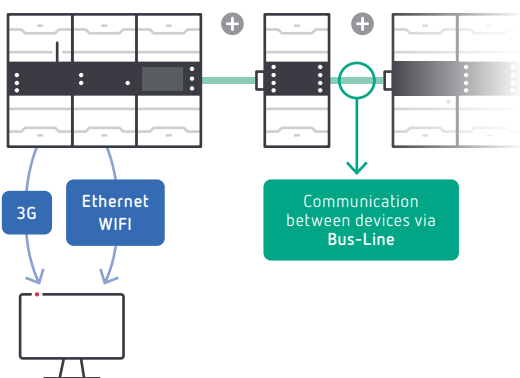

## Line-EDS

### Datalogger with integrated webserver

**Line-EDS-Cloud** has been designed to read any type of data and automatically upload it to the major Big Data platforms.

The device features Wi-Fi communications for simple set-up and start-up. It has Ethernet and RS-485 ports for reading and setting up any device connected to it.

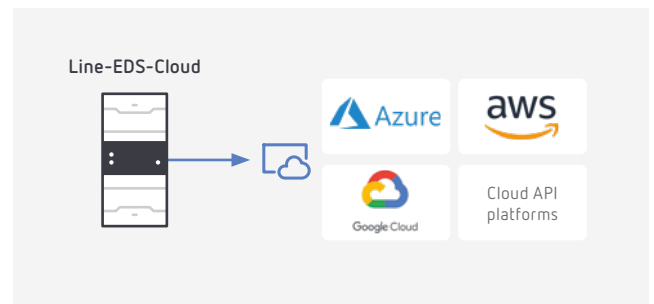

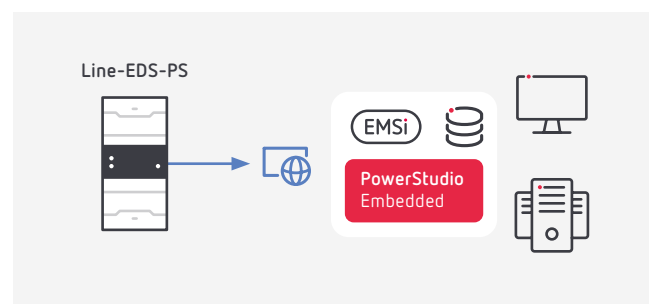

**Line-EDS-PS/-PSS/-PSS-PRO** incorporates all the features of a powerful data monitoring, control and data acquisition software (SCADA) into a single device.

Monitor your installation using Wi-Fi, Ethernet or 3G communications locally or remotely. Every model has a generic Modbus driver for integration with any product on the market.







KEY FEATURES



Multiple options for communicating with the user

-  Ethernet (Webserver)
-  Wi-Fi
-  3G (optional)



Easy communication with other devices

-  Bus-Line
-  RS-485 Modbus RTU
-  Ethernet Modbus TCP
-  Modbus generic driver

Data display and recording

-  PowerStudio Embedded
-  Cloud
-  Memory (up to 1 year of data)

Control of installations

-  Alarms
-  2 transistor outputs
-  SCADA displays

Comparison between Line-EDS-PS devices

Features	Line-EDS-PS	Line-EDS-PSS	Line-EDS-PSS-PRO
Customized SCADA screens	-	2	5
Customized reports/billling simulation	-	2	5
Event scheduling	10	20	40
Programming of calculated variables	10	20	40
CIRCUTOR or Generic Modbus RTU and TCP slave devices	5	10	20

Table of references

Type	Code	Integrated software	TR out-puts	Generic Modbus	Communications	Protocol
Line-EDS-Cloud	[*] M61055.	APIs from Azure, AWS, GOOGLE, Cloud API platforms	2	●	Ethernet / Wi-Fi / RS-485 / Bus-Line	Web platform Modbus/APIs
Line-EDS-PS	[*] M61095.	PowerStudio	2	●	Ethernet/Wi-Fi/RS-485/Bus-Line	CIRCUTOR + Generic/XML Modbus
Line-EDS-PSS	[*] M61085.	PowerStudio SCADA	2	●	Ethernet/Wi-Fi/RS-485/Bus-Line	CIRCUTOR + Generic/XML Modbus
Line-EDS-PSS-PRO	[*] M61065.	PowerStudio SCADA PRO	2	●	Ethernet / Wi-Fi / RS-485 / Bus-Line	CIRCUTOR + Generic/XML Modbus

Bus-Line: RS-485 communications system, with side connector between modules

**Line System devices.**  
It has never been easier.













## Line-CVM

Three-phase, indirect power analyzer

**Line-CVM-D32** Power analyzer to monitor and measure more than 250 electric variables in both medium- and low-voltage networks. Designed to properly manage the quality of consumption and supply, by reading harmonics and recording the number of power quality events counter (swells, dips and interruptions) that occur in the installation.

Key features:

-  Measurement of electrical variables
-  Power quality events counter (swells, dips and interruptions)
-  Measures up to the 40th harmonic
-  Energy cost measurement
-  Consumption and generation measurement (4 quadrants)
-  Sealable
-  RS-485 port (Modbus RTU) for reading and configuration
-  Two digital outputs to generate impulses or alarms
-  Measurement of CO<sub>2</sub> emissions
-  Record of operating hours for preventive maintenance
-  Terminals with Plug&ON system



## Line-M-4IO

Input/output modules

For connecting to line-EDS or Line-CVM-D32 devices.

### 4 digital inputs and outputs

#### Line-M-4IO-T





Module with 4 inputs and 4 transistor outputs (free of voltage).

#### Line-M-4IO-R

Module with 4 inputs and 4 relay outputs.

#### Line-M-4IO-RV

Module with 4 inputs (230 Vac) and 4 relay outputs.



INPUTS	OUTPUTS
 Water, energy, gas, thermal energy and other meters.	 Alarms (instantaneous values)
 Monitor status of sensors and protection devices (On/Off)	 Pulses from incremental variables (energies, costs, CO <sub>2</sub> emissions or working time).*
 Tariff change	

\*Only for the Line-M-4IO-T model

### 4 analogue inputs and outputs

#### Line-M-4IO-A

Module with 4 analogue inputs and 4 analogue outputs. Inputs for integrating 0/4... 20 mA signals from external sensors or devices. Programmable outputs from 0/4... 20 mA or 0/2... 10 V, replicating measured signals through their inputs or instantaneous variables measured by devices connected to the Line system.

INPUTS	OUTPUTS
 Temperature (°C), Flow rate (m <sup>3</sup> ), Pressure (kPa), Level (l)	 Values of analogue inputs
	 Instantaneous electrical variables: Voltage, Current, Power, etc.



## Line-M-20I

Module with 20 digital inputs

Module with 20 digital inputs to read consumption using pulses from any type of meter (electricity, water, gas, etc.) or to detect the status (ON/OFF) of any device or sensor associated with a control system (people, units, protection, actuation, alarms, etc.).

### Three communication options

Line-M-20I features versatile communications, and can be connected directly via the Line-TCPRS1, Line-EDS or Line-CVM module.

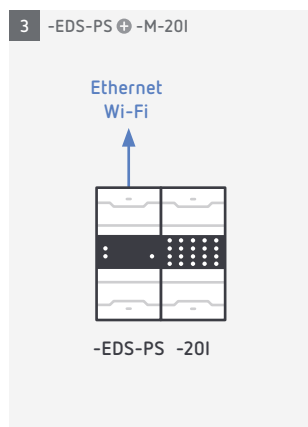
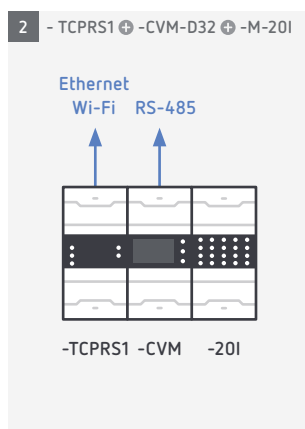
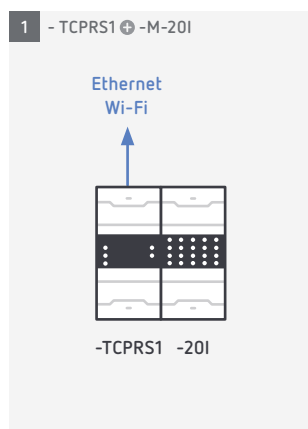

## Line-TCPRS1

RS-485 to Ethernet/Wi-Fi converter

Communications gateway designed to convert an RS-485 physical environment to Ethernet and/or Wi-Fi in order to connect to Line-CVM or Line-M-20I. Allows using a single IP to connect to and configure all the devices connected to the RS-485 or Bus-Line communications bus.

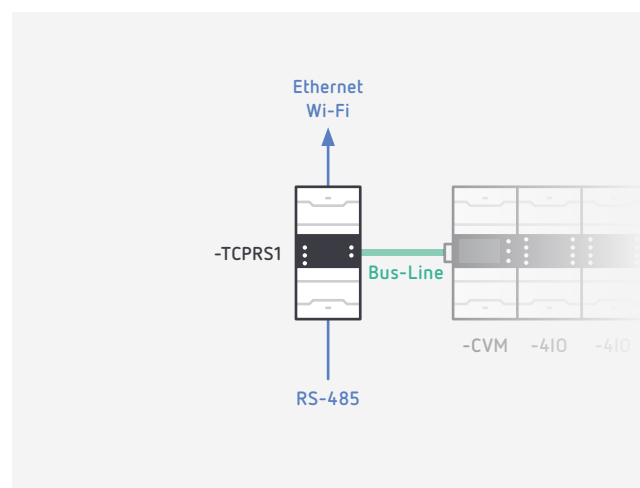



**Line System devices.**  
It has never been easier.



## Line-M-3G

Modem for 3G communications

Module to provide 3G communications to the **line-EDS** unit and to the devices connected to it. Allows remote access from anywhere without the need for communications wiring.

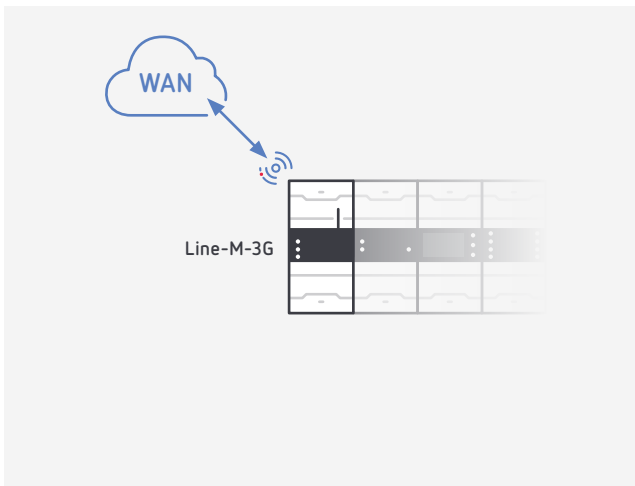

## Line-M-EXT-PS

Power supply up to 480V

This module allows the system to be expanded by connecting more devices on the **Bus-Line**, without the need for external power in the remaining modules. The system can thus be extended as the needs of the installation grow. It also makes it possible to install **Line** devices on networks of up to 480V.

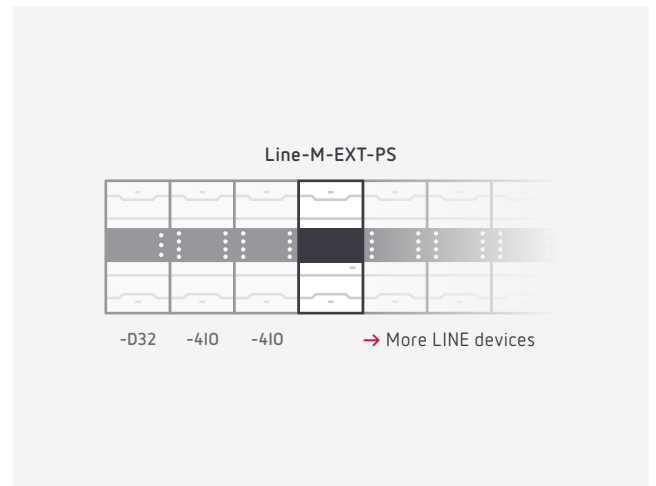

Install one **Line-M-PS** device every 3 modules of the **Line** series, or check with CIRCUTOR for your specific installation.

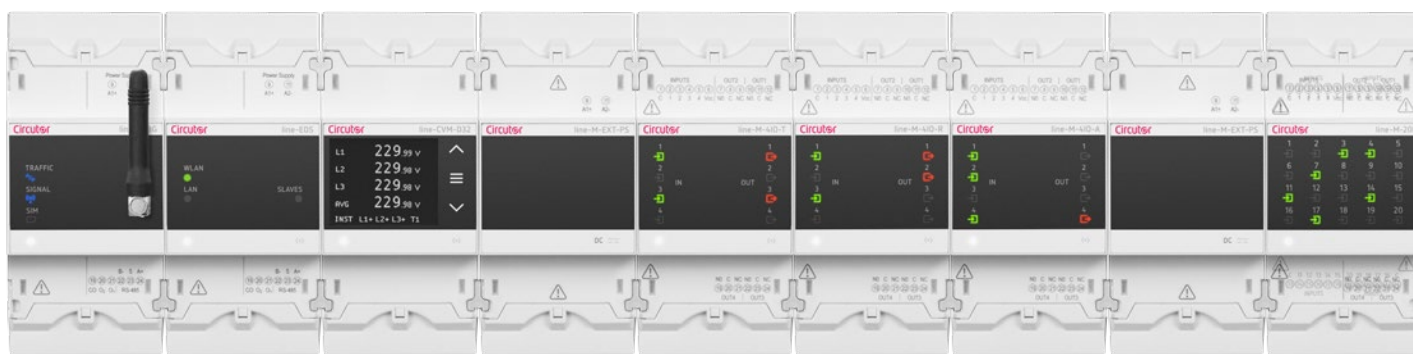

TABLE OF REFERENCES

Power analyzer

Type	Code	Measurement channels	Input current	TR outputs	Communications	Protocol	Harmonics
Line-CVM-D32	M58100.	3	.../5A, .../1A or .../0.250 A	2	RS-485/Bus-Line	Modbus/RTU	40

Bus-Line: RS-485 communications system, with side connector between modules

Inputs/Outputs

Type	Code	TR outputs	RL outputs	Digital inputs	Analogue inputs	Analogue outputs	Communications	Protocol
Line-M-4IO-T	M58E01.	4	-	4	-	-	Bus-Line	Modbus/RTU
Line-M-4IO-R	M58E02.	-	4	4	-	-	Bus-Line	Modbus/RTU
Line-M-4IO-A	M58E03.	-	-	-	4: (0/4 ... 20mA)	4: (0/4 ... 20 mA), (0/2 ... 10 Vdc)	Bus-Line	Modbus/RTU
Line-M-4IO-RV	M58E04.	-	4	4 (230 V)	-	-	Bus-Line	Modbus/RTU
Line-M-20I	M58E06.	-	-	20	-	-	Bus-Line	Modbus/RTU

Bus-Line: RS-485 communications system, with side connector between modules

Communications

Type	Code	Description
Line-M-3G	M58E05.	3G communications modem and <b>Bus-Line</b> to communicate with the <b>Line</b> system's devices
Line-TCPRS1	M62411.	RS-485 (Modbus RTU) to Ethernet or Wi-Fi (Modbus TCP) converter

Bus-Line: RS-485 communications system, with side connector between modules

Accessories

Type	Code	Description
Line-M-EXT-PS	M58E0A.	110-277 V ~ (P-N)/110-480 V ~ (P-P) power supply to drive devices connected to the <b>Bus-Line</b> .

Bus-Line: RS-485 communications system, with side connector between modules

# integrated Energy Management System



## Control and manage your installation

The devices in the **Line** system paved the way for the **EMSi** concept, which combines the **management of different types of energy consumption and the management of multiple control and maintenance systems** (lighting, HVAC, etc.) into a single solution.

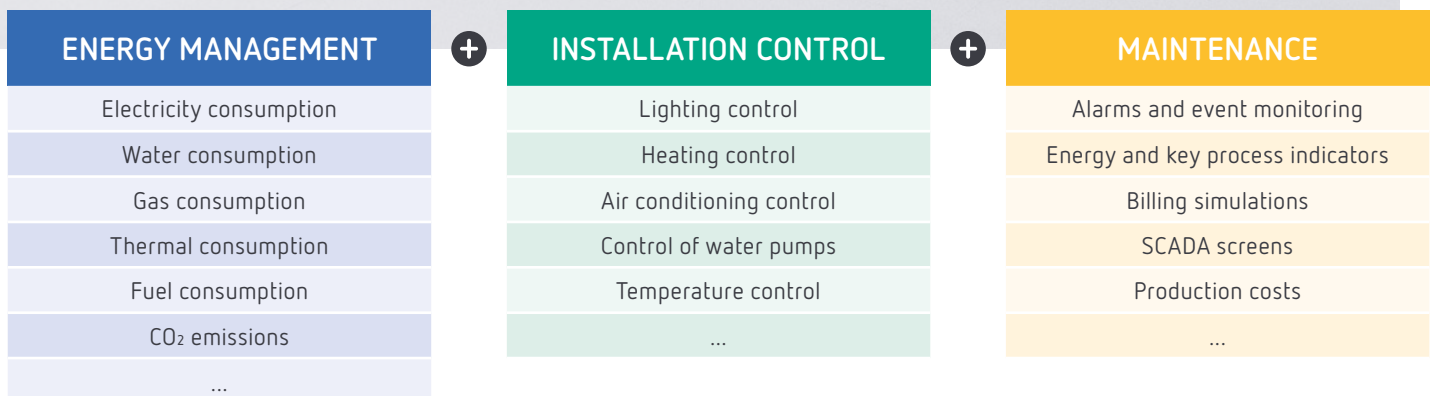



## Management of all your consumption

The EMSi system records all the information on your installation's energy consumption, which it can monitor in real time, display it on graphs, compare data from different periods or display it in data tables so it can be exported outside the application.

The data acquisition is very simple; using the **line-EDS** device, you can add any meter with Modbus communications to the EMSi system; the **Line-M** devices with digital inputs let you record consumption using any meter with a pulse output. The electricity consumption is recorded using the **Line-CVM-D32** analyzer.

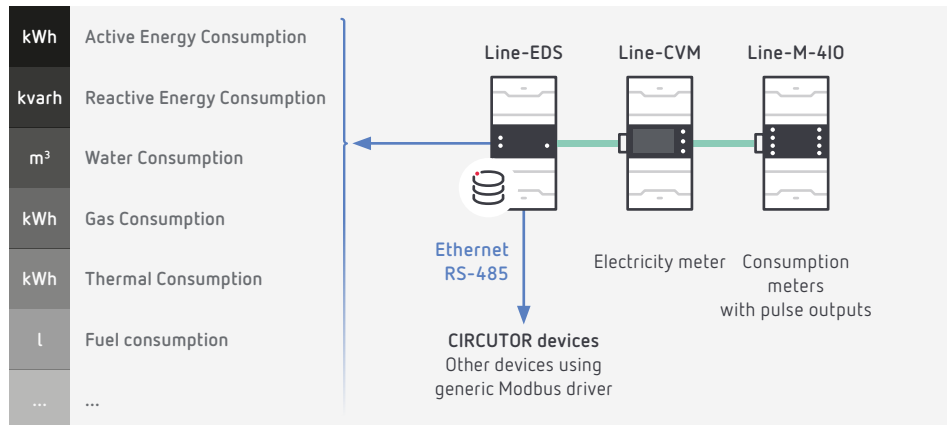

The EMSi software integrated into **line-EDS** lets you create SCADA displays to show, in real time, where, how, when and how much energy your installation is consuming. This information lets you save on costs and manage the installation globally based on the ISO 50001 standard.

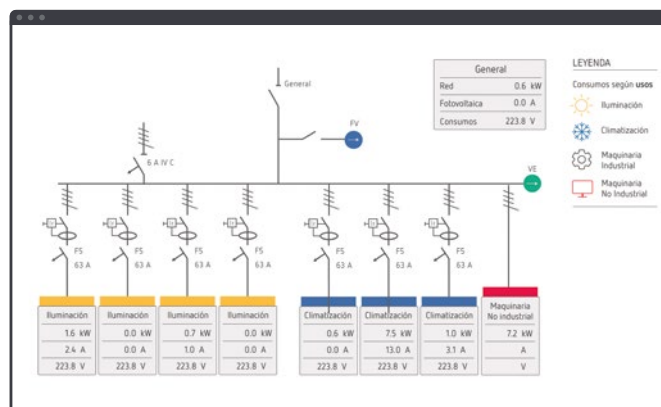

↑ Find out how and where you consume energy.

← Monitor every circuit in your installation



## Monitor any type of installation

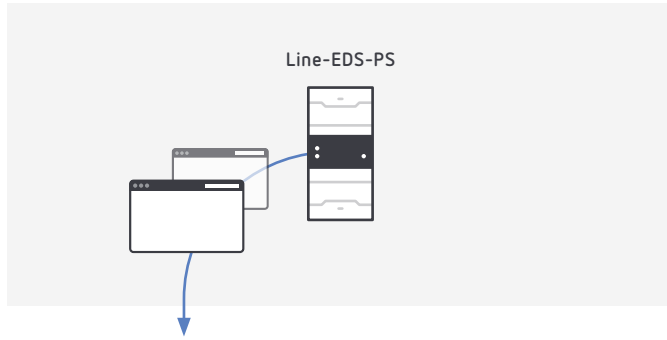

Install **Line-EDS** and integrate any Modbus RTU or Modbus TCP device that is present in your installation (temperature, humidity, pressure, level or other kind of probe).

Create SCADA screens to control all your automation systems from a single device (**Line-EDS**). You can use any web browser or **PowerStudio Server** to control and display the status of your installation in real time, change any setpoint and receive alarms to improve the management of all your control systems.

Easily and dynamically display any regulation system required, such as:



Example of lighting control

### Lighting control

Configure setpoints to automatically turn lights on and off, on a set schedule or by using the astronomical clock feature. It also offers the option to control lighting systems by creating a work schedule, with or without inputs from motion sensors.

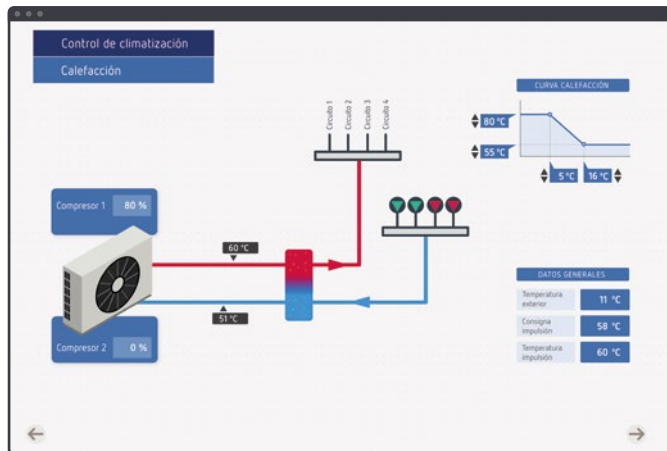

Example of HVAC control

### HVAC control

Take external temperature readings, compare them with the setpoint and turn on the HVAC system to drive and monitor the hot water loop. Monitor the condition of the compressors to display the percent load on each and verify they are working correctly.



Example of temperature control

### Temperature control

Check the status of each HVAC unit and adjust the hot/cold setpoints as needed. Create calendars or schedules to program automatic on/off switching times. Each device can be set based on the schedule or workday, with the option to incorporate motion sensors into the control system.

Note: The sample screens shown are not set up by default on Line-EDS devices. Each user will be able to generate their own screens based on their needs.





## Maintenance of any installation

Program any type of alarm to monitor the installation depending on the variables of the connected devices. If any parameter is outside its programmed values, the system will adjust the installation and/or send an e-mail instantly.

Fecha y hora	Nombre	Activación	Activación programada	Activación desactivada	Recurrencia en	Creado/Modificado en
27 07 00:00	CL.MIA.FM.LINCA 1 TAMA 8 PH.OHA1 SENSALIZADORA				No aplicable	15/11/2019
27 07 00:01	CL.MIA.DA.LABORAL				No aplicable	15/11/2019
27 07 00:00	CL.MIA.SATA.FM.F HORARIO LABORAL ACTIVO				No aplicable	15/11/2019
27 07 00:00	CL.MIA.SATA.CM2 HORARIO LABORAL ACTIVO				No aplicable	15/11/2019
27 07 00:00	CL.MIA.SATA.CM3 HORARIO LABORAL ACTIVO				No aplicable	15/11/2019
27 07 00:00	CL.MIA.SATA.CM4 HORARIO LABORAL ACTIVO				No aplicable	15/11/2019
27 07 00:00	CL.MIA.SATA.CM5 HORARIO LABORAL ACTIVO				No aplicable	15/11/2019
27 07 00:00	CL.MIA.SATA.CM6 HORARIO LABORAL ACTIVO				No aplicable	15/11/2019
27 07 00:00	CL.MIA.SATA.CM7 HORARIO LABORAL ACTIVO				No aplicable	15/11/2019
27 07 00:00	CL.MIA.SATA.CM8 HORARIO LABORAL ACTIVO				No aplicable	15/11/2019
27 07 00:00	CL.MIA.SATA.CM9 HORARIO LABORAL ACTIVO				No aplicable	15/11/2019
27 07 00:00	CL.MIA.SATA.CM10 HORARIO LABORAL ACTIVO				No aplicable	15/11/2019
27 07 00:00	CL.MIA.SATA.CM11 HORARIO LABORAL ACTIVO				No aplicable	15/11/2019
27 07 00:00	CL.MIA.SATA.CM12 HORARIO LABORAL ACTIVO				No aplicable	15/11/2019
27 07 00:00	CL.MIA.SATA.CM13 HORARIO LABORAL ACTIVO				No aplicable	15/11/2019
27 07 00:00	CL.MIA.SATA.CM14 HORARIO LABORAL ACTIVO				No aplicable	15/11/2019
27 07 00:00	CL.MIA.SATA.CM15 HORARIO LABORAL ACTIVO				No aplicable	15/11/2019
27 07 00:00	CL.MIA.SATA.CM16 HORARIO LABORAL ACTIVO				No aplicable	15/11/2019
27 07 00:00	CL.MIA.SATA.CM17 HORARIO LABORAL ACTIVO				No aplicable	15/11/2019
27 07 00:00	CL.MIA.SATA.CM18 HORARIO LABORAL ACTIVO				No aplicable	15/11/2019
27 07 00:00	CL.MIA.SATA.CM19 HORARIO LABORAL ACTIVO				No aplicable	15/11/2019
27 07 00:00	CL.MIA.SATA.CM20 HORARIO LABORAL ACTIVO				No aplicable	15/11/2019
27 07 00:00	CL.MIA.SATA.CM21 HORARIO LABORAL ACTIVO				No aplicable	15/11/2019
27 07 00:00	CL.MIA.SATA.CM22 HORARIO LABORAL ACTIVO				No aplicable	15/11/2019
27 07 00:00	CL.MIA.SATA.CM23 HORARIO LABORAL ACTIVO				No aplicable	15/11/2019
27 07 00:00	CL.MIA.SATA.CM24 HORARIO LABORAL ACTIVO				No aplicable	15/11/2019
27 07 00:00	CL.MIA.SATA.CM25 HORARIO LABORAL ACTIVO				No aplicable	15/11/2019
27 07 00:00	CL.MIA.SATA.CM26 HORARIO LABORAL ACTIVO				No aplicable	15/11/2019
27 07 00:00	CL.MIA.SATA.CM27 HORARIO LABORAL ACTIVO				No aplicable	15/11/2019
27 07 00:00	CL.MIA.SATA.CM28 HORARIO LABORAL ACTIVO				No aplicable	15/11/2019
27 07 00:00	CL.MIA.SATA.CM29 HORARIO LABORAL ACTIVO				No aplicable	15/11/2019
27 07 00:00	CL.MIA.SATA.CM30 HORARIO LABORAL ACTIVO				No aplicable	15/11/2019
27 07 00:00	CL.MIA.SATA.CM31 HORARIO LABORAL ACTIVO				No aplicable	15/11/2019
27 07 00:00	CL.MIA.SATA.CM32 HORARIO LABORAL ACTIVO				No aplicable	15/11/2019
27 07 00:00	CL.MIA.SATA.CM33 HORARIO LABORAL ACTIVO				No aplicable	15/11/2019
27 07 00:00	CL.MIA.SATA.CM34 HORARIO LABORAL ACTIVO				No aplicable	15/11/2019
27 07 00:00	CL.MIA.SATA.CM35 HORARIO LABORAL ACTIVO				No aplicable	15/11/2019
27 07 00:00	CL.MIA.SATA.CM36 HORARIO LABORAL ACTIVO				No aplicable	15/11/2019
27 07 00:00	CL.MIA.SATA.CM37 HORARIO LABORAL ACTIVO				No aplicable	15/11/2019
27 07 00:00	CL.MIA.SATA.CM38 HORARIO LABORAL ACTIVO				No aplicable	15/11/2019
27 07 00:00	CL.MIA.SATA.CM39 HORARIO LABORAL ACTIVO				No aplicable	15/11/2019
27 07 00:00	CL.MIA.SATA.CM40 HORARIO LABORAL ACTIVO				No aplicable	15/11/2019
27 07 00:00	CL.MIA.SATA.CM41 HORARIO LABORAL ACTIVO				No aplicable	15/11/2019
27 07 00:00	CL.MIA.SATA.CM42 HORARIO LABORAL ACTIVO				No aplicable	15/11/2019
27 07 00:00	CL.MIA.SATA.CM43 HORARIO LABORAL ACTIVO				No aplicable	15/11/2019
27 07 00:00	CL.MIA.SATA.CM44 HORARIO LABORAL ACTIVO				No aplicable	15/11/2019
27 07 00:00	CL.MIA.SATA.CM45 HORARIO LABORAL ACTIVO				No aplicable	15/11/2019
27 07 00:00	CL.MIA.SATA.CM46 HORARIO LABORAL ACTIVO				No aplicable	15/11/2019
27 07 00:00	CL.MIA.SATA.CM47 HORARIO LABORAL ACTIVO				No aplicable	15/11/2019
27 07 00:00	CL.MIA.SATA.CM48 HORARIO LABORAL ACTIVO				No aplicable	15/11/2019
27 07 00:00	CL.MIA.SATA.CM49 HORARIO LABORAL ACTIVO				No aplicable	15/11/2019
27 07 00:00	CL.MIA.SATA.CM50 HORARIO LABORAL ACTIVO				No aplicable	15/11/2019
27 07 00:00	CL.MIA.SATA.CM51 HORARIO LABORAL ACTIVO				No aplicable	15/11/2019
27 07 00:00	CL.MIA.SATA.CM52 HORARIO LABORAL ACTIVO				No aplicable	15/11/2019
27 07 00:00	CL.MIA.SATA.CM53 HORARIO LABORAL ACTIVO				No aplicable	15/11/2019
27 07 00:00	CL.MIA.SATA.CM54 HORARIO LABORAL ACTIVO				No aplicable	15/11/2019
27 07 00:00	CL.MIA.SATA.CM55 HORARIO LABORAL ACTIVO				No aplicable	15/11/2019
27 07 00:00	CL.MIA.SATA.CM56 HORARIO LABORAL ACTIVO				No aplicable	15/11/2019
27 07 00:00	CL.MIA.SATA.CM57 HORARIO LABORAL ACTIVO				No aplicable	15/11/2019
27 07 00:00	CL.MIA.SATA.CM58 HORARIO LABORAL ACTIVO				No aplicable	15/11/2019
27 07 00:00	CL.MIA.SATA.CM59 HORARIO LABORAL ACTIVO				No aplicable	15/11/2019
27 07 00:00	CL.MIA.SATA.CM60 HORARIO LABORAL ACTIVO				No aplicable	15/11/2019
27 07 00:00	CL.MIA.SATA.CM61 HORARIO LABORAL ACTIVO				No aplicable	15/11/2019
27 07 00:00	CL.MIA.SATA.CM62 HORARIO LABORAL ACTIVO				No aplicable	15/11/2019
27 07 00:00	CL.MIA.SATA.CM63 HORARIO LABORAL ACTIVO				No aplicable	15/11/2019
27 07 00:00	CL.MIA.SATA.CM64 HORARIO LABORAL ACTIVO				No aplicable	15/11/2019
27 07 00:00	CL.MIA.SATA.CM65 HORARIO LABORAL ACTIVO				No aplicable	15/11/2019
27 07 00:00	CL.MIA.SATA.CM66 HORARIO LABORAL ACTIVO				No aplicable	15/11/2019
27 07 00:00	CL.MIA.SATA.CM67 HORARIO LABORAL ACTIVO				No aplicable	15/11/2019
27 07 00:00	CL.MIA.SATA.CM68 HORARIO LABORAL ACTIVO				No aplicable	15/11/2019
27 07 00:00	CL.MIA.SATA.CM69 HORARIO LABORAL ACTIVO				No aplicable	15/11/2019
27 07 00:00	CL.MIA.SATA.CM70 HORARIO LABORAL ACTIVO				No aplicable	15/11/2019
27 07 00:00	CL.MIA.SATA.CM71 HORARIO LABORAL ACTIVO				No aplicable	15/11/2019
27 07 00:00	CL.MIA.SATA.CM72 HORARIO LABORAL ACTIVO				No aplicable	15/11/2019
27 07 00:00	CL.MIA.SATA.CM73 HORARIO LABORAL ACTIVO				No aplicable	15/11/2019
27 07 00:00	CL.MIA.SATA.CM74 HORARIO LABORAL ACTIVO				No aplicable	15/11/2019
27 07 00:00	CL.MIA.SATA.CM75 HORARIO LABORAL ACTIVO				No aplicable	15/11/2019
27 07 00:00	CL.MIA.SATA.CM76 HORARIO LABORAL ACTIVO				No aplicable	15/11/2019
27 07 00:00	CL.MIA.SATA.CM77 HORARIO LABORAL ACTIVO				No aplicable	15/11/2019
27 07 00:00	CL.MIA.SATA.CM78 HORARIO LABORAL ACTIVO				No aplicable	15/11/2019
27 07 00:00	CL.MIA.SATA.CM79 HORARIO LABORAL ACTIVO				No aplicable	15/11/2019
27 07 00:00	CL.MIA.SATA.CM80 HORARIO LABORAL ACTIVO				No aplicable	15/11/2019
27 07 00:00	CL.MIA.SATA.CM81 HORARIO LABORAL ACTIVO				No aplicable	15/11/2019
27 07 00:00	CL.MIA.SATA.CM82 HORARIO LABORAL ACTIVO				No aplicable	15/11/2019
27 07 00:00	CL.MIA.SATA.CM83 HORARIO LABORAL ACTIVO				No aplicable	15/11/2019
27 07 00:00	CL.MIA.SATA.CM84 HORARIO LABORAL ACTIVO				No aplicable	15/11/2019
27 07 00:00	CL.MIA.SATA.CM85 HORARIO LABORAL ACTIVO				No aplicable	15/11/2019
27 07 00:00	CL.MIA.SATA.CM86 HORARIO LABORAL ACTIVO				No aplicable	15/11/2019
27 07 00:00	CL.MIA.SATA.CM87 HORARIO LABORAL ACTIVO				No aplicable	15/11/2019
27 07 00:00	CL.MIA.SATA.CM88 HORARIO LABORAL ACTIVO				No aplicable	15/11/2019
27 07 00:00	CL.MIA.SATA.CM89 HORARIO LABORAL ACTIVO				No aplicable	15/11/2019
27 07 00:00	CL.MIA.SATA.CM90 HORARIO LABORAL ACTIVO				No aplicable	15/11/2019
27 07 00:00	CL.MIA.SATA.CM91 HORARIO LABORAL ACTIVO				No aplicable	15/11/2019
27 07 00:00	CL.MIA.SATA.CM92 HORARIO LABORAL ACTIVO				No aplicable	15/11/2019
27 07 00:00	CL.MIA.SATA.CM93 HORARIO LABORAL ACTIVO				No aplicable	15/11/2019
27 07 00:00	CL.MIA.SATA.CM94 HORARIO LABORAL ACTIVO				No aplicable	15/11/2019
27 07 00:00	CL.MIA.SATA.CM95 HORARIO LABORAL ACTIVO				No aplicable	15/11/2019
27 07 00:00	CL.MIA.SATA.CM96 HORARIO LABORAL ACTIVO				No aplicable	15/11/2019
27 07 00:00	CL.MIA.SATA.CM97 HORARIO LABORAL ACTIVO				No aplicable	15/11/2019
27 07 00:00	CL.MIA.SATA.CM98 HORARIO LABORAL ACTIVO				No aplicable	15/11/2019
27 07 00:00	CL.MIA.SATA.CM99 HORARIO LABORAL ACTIVO				No aplicable	15/11/2019
27 07 00:00	CL.MIA.SATA.CM100 HORARIO LABORAL ACTIVO				No aplicable	15/11/2019

It combines every aspect of energy control into a single tool, providing invoice simulations based on the energy consumption of any meter.

Know what the utility will bill in advance and schedule an automatic notification to compare and improve the efficiency of your consumption.

**Resumen de la factura**

Fecha Factura: 15/11/2019

Periodo facturación de 01/11/2019 al 01/12/2019

Total factura: **9.828.63 €**

**Facturación**

CONCEPTO	CÁLCULO	IMPORTE
<b>Término de energía variable</b>		<b>4.468.87 €</b>
Periodo 1	13.773 kWh x 0.099342 €/kWh =	1.368.24 €
Periodo 2	21.110 kWh x 0.086493 €/kWh =	1.825.87 €
Periodo 3	20.142 kWh x 0.063289 €/kWh =	1.274.77 €
<b>Facturación potencia periodos</b>		<b>3.258.86 €</b>
Periodo 1	374.0 kW x 59.475288 €/kW =	22.243.76 €
Periodo 2	374.0 kW x 36.676813 €/kW =	13.717.13 €
Periodo 3	374.0 kW x 8.410411 €/kW =	3.145.49 €
<b>Energía reactiva</b>	39.106.38 € (12 MESES)	<b>0.00 €</b>

**Iluminación** 55.4 kW 29%

Zona	Potencia (kW)	Consumo (%)	W/m²
<b>Comercial</b>	25.6 kW	45 %	4 W/m²
<b>Ingeniería</b>	19 kW	34 %	6 W/m²
Oficinas	8.8 kW	34 %	3 W/m²
Lab. Metering	3.4 kW	13 %	4 W/m²
Laboratorio	0.0 kW	0 %	0 W/m²
Ed. Social	0.0 kW	0 %	0 W/m²
Almacén	13.3 kW	52 %	5 W/m²
Almacén	1.7 kW	9 %	4 W/m²
Producción	10.7 kW	56 %	9 W/m²
Oficinas	2.2 kW	11 %	6 W/m²
Oficinas I+D	4.5 kW	24 %	7 W/m²
Montaje	10.9 kW	20 %	7 W/m²

Create Energy Performance Indicators (EnPI) to check if energy improvement actions are working correctly. Create your own KPI, depending on your installation and processes.

Typical performance indicators:

kWh/unit produced	Industry
kWh/m³	Water treatment or pumping stations
kWh/external temp.	HVAC
kWh/m²	Buildings or Supermarkets
kWh/occupation	Hotels



Vial Sant Jordi, s/n  
08232 Viladecavalls  
Barcelona (Spain)  
T +34. 93 745 29 00  
[info@circuitor.com](mailto:info@circuitor.com)

C2M6C3-01

CIRCUTOR, SA reserves the right to modify any information contained in this catalogue.