

# RXT-4112 CWDM OTDR Module



## RXT-1200 Modular Test Platform

The RXT-4112 test module for the VeEX® RXT-1200 platform features a range of Optical test functions including CWDM OTDR, OPM, Light Source and VFL. Multi-protocol networks utilizing CWDM technology can easily be verified with a single test platform ensuring maximum test productivity.



## Platform Highlights

### Software

- Flexible software architecture supports simultaneous test applications
- VeExpress™ Cloud or Enterprise server versions to maintain instrument firmware and manage test assets or inventory
- ReVeal™ PC software to manage test configurations, process measurement results and generate customer test reports
- Fiberizer Desktop PC software for advanced trace analysis
- Fiberizer Cloud trace analysis and data management
- R-server support for centralized work force management and test results repository
- Optional Fiber Inspection Scope (USB) support with V-Scope function

### Hardware

- High resolution, 7" full color TFT touch-screen viewable in any lighting condition
- Connectivity via 10/100Base-T Management interface, WiFi™, Bluetooth®, or 3G Card for back office applications
- Built-in microphone and speaker for VoIP & VF applications
- Intelligent fan operation with built-in temperature sensor
- Interchangeable Li-ion battery pack for extended test time
- USB-A Interface for USB flash drives, USB wireless dongles and fiber inspection probe connection
- Optional built-in GPS module for Geotagging OTDR traces

## Key Features

### Optical Testing

- Characterize CWDM networks at ITU-T G.694.2 wavelengths
- End-to-end continuity testing using stabilized CWDM light source (via OTDR port)
- OTDR port features live fiber detection
- High dynamic range (up to 42 dB) for long haul fibers and testing through CWDM multiplexers/OADMs/de-multiplexers
- Sampling points up to 128,000
- Optimized test parameters for best in class dead zones
- Event dead zone < 1m, Attenuation dead zone < 4m
- Telcordia GR-196 and SR-4731.sor file formats
- Optional V-Scout mode – Intelligent Link Mapping using intuitive icons derived from multiple test acquisitions
- Optional Built-in Visual Fault Locator
- Optional Optical Power Meter
- Optional CWDM Light Source via OTDR port
- Upload OTDR traces and Fiberscope images directly to Fiberizer Cloud via wired or wireless internet connection
- Universal 2.5 mm optical interfaces with inter-changeable optical adaptors (SC/FC/ST/LC)



Add value with  
**Fiberizer Cloud**  
[www.fiberizer.com](http://www.fiberizer.com)

## CWDM

Coarse Wavelength Division Multiplexing (CWDM) is a cost-effective alternative to DWDM for many metro and regional network applications. Technically simpler to implement than DWDM, CWDM is a cheaper way to address bandwidth growth demands without overbuilding the infrastructure.

ITU-T G.694.2 defines 18 wavelengths from 1271 to 1611 nm spaced 20 nm apart for CWDM transport. Leveraging the powerful “tried-and-tested” RXT-1200 platform, the RXT-4112 OTDR module tackles CWDM network test challenges head-on.

### Test Application

Telco, Mobile and CATV operators offering or utilizing CWDM technology need to characterize, maintain and troubleshoot CWDM fiber networks using new OTDR test methods

- Networks need to be verified at the discrete ITU G.694.2 wavelengths
- End-to-end loss through multiplexers, OADM and de-multiplexers needs to be checked
- Attenuation at the various CWDM wavelengths must be within specification
- End-to-end continuity testing using stable source should be performed prior to service turn up
- Wavelength provisioning - verify new wavelength services and routes without disrupting traffic on active channels

### OTDR Display

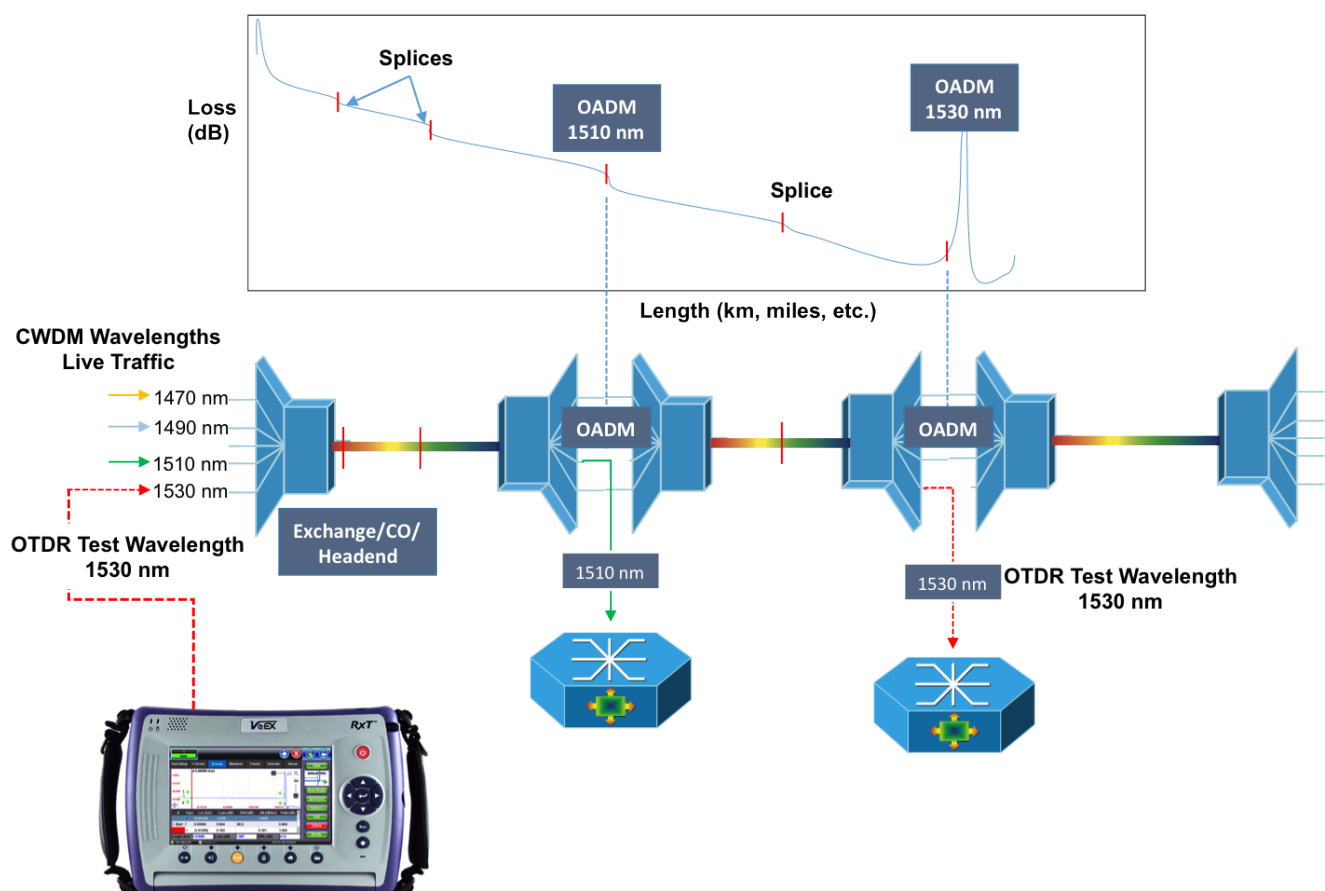

### The RXT-4112 CWDM OTDR Solution

Fiber centric Ethernet is fast becoming the dominant access and metro technology for many operators, and field technicians have to be equipped with a test solution that allows them to characterize the fiber as well as the Ethernet transmission running over it. The powerful RXT-4112 CWDM OTDR responds to this demand by integrating the right combination of optical tools and test features so that a fiber link can be qualified in a single platform, eliminating additional truck rolls. The RXT-4112 CWDM OTDR all-in-one Optical solution offers:

- Singlemode CWDM OTDR - locate and characterize fiber link, splice and connector losses
- Power meter and Light Source - perform power and loss measurements
- Visual Fault Locator - check patch cords and enclosures for light leakage
- Fiberscope - check dirty and/or damaged connectors

# Optical Time Domain Reflectometer (OTDR)

## Intuitive Test Setup

An intuitive menu structure offers simple test setup for Novice and Expert users alike. Test parameters can be configured manually by the user or set automatically by the unit.

CWDM wavelength combinations are supported via different test modules. Up to 4 wavelengths are supported by each module.

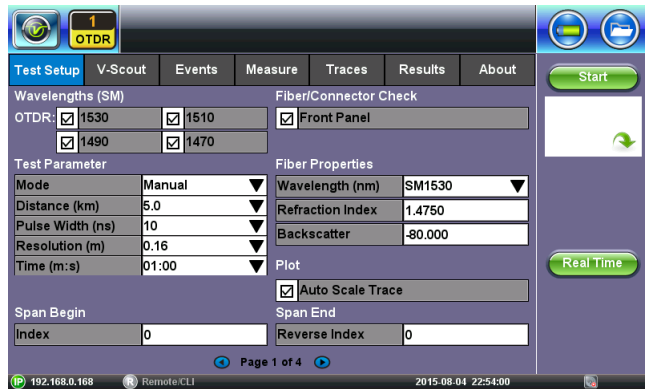

## Analysis Thresholds

User defined thresholds for splice loss, connector loss, fiber lengths and reflectance can be preset to assess a fiber's condition. Color coding used in the event table will display events exceeding Pass/Fail thresholds and alert technicians of a potential problem.

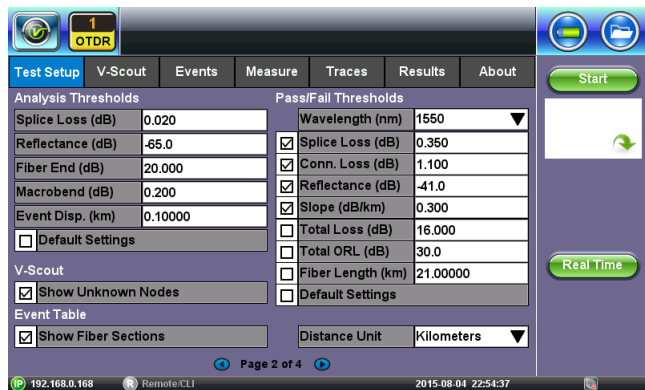

## V-Scout Link Mapping

Advanced algorithms evaluate separate acquisitions and characterize the fiber span using intuitive symbols. Each individual acquisition can be customized and user defined as a test profile depending on network type or application. This optional feature eliminates event interpretation and provides greater analysis confidence to the user, regardless of OTDR skill set.

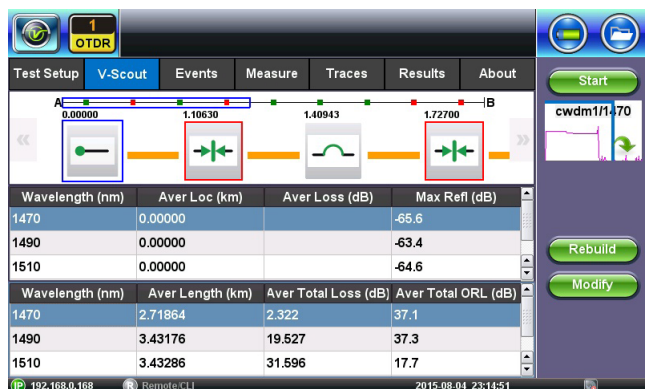

## Advanced Trace Analysis

Reliable event detection and accurate analysis are crucial to document fiber links at the time of installation. These baseline records are essential to troubleshooting faulty fiber networks and reducing system downtime afterwards.

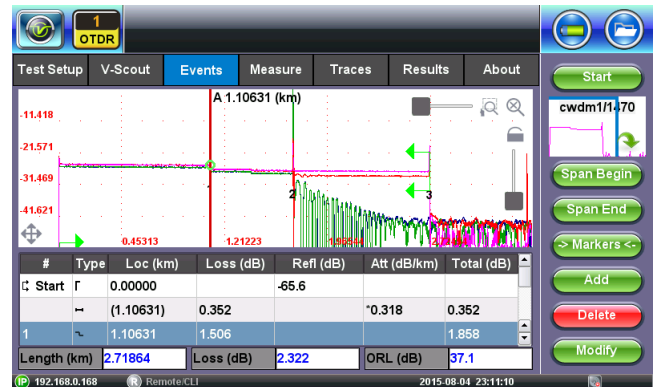

The OTDR module employs specialized software and algorithms developed from decades of experience to locate and measure connectors, splices, optical splitters and macro-bends.

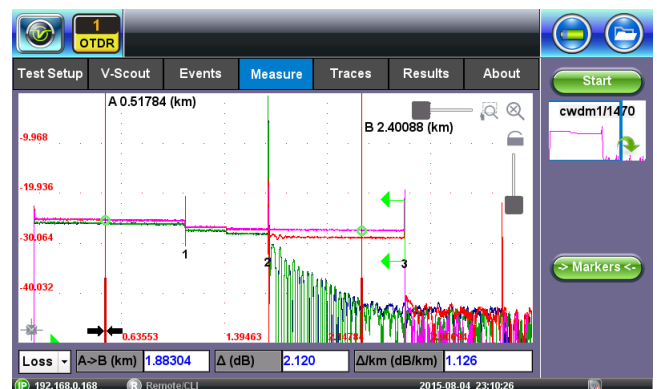

## OTDR Results

OTDR Traces are saved in Telcordia SR-4731 format which is compatible with all other OTDR vendor trace viewer software. OTDR sor files are saved in a logical hierarchy for easy sorting and storage.

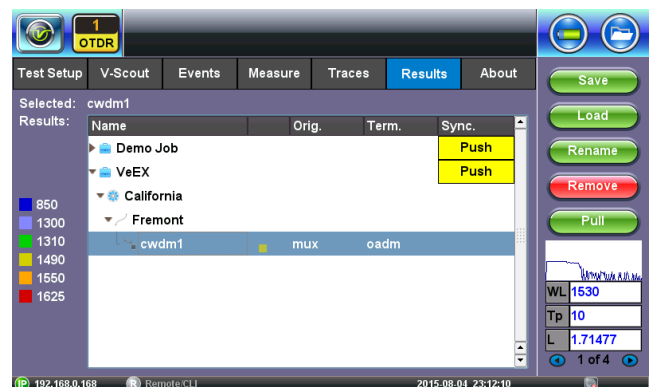

## Fiber Inspection Scope

Dirty or damaged optical connectors can lead to serious problems and often account for a large percentage of network failures. Furthermore, bad scratches to the ferrule end face can impact transmission quality because large optical reflections produce bit errors in high data rate systems.

With the optional Fiber inspection probe, connector cleanliness and quality can be easily tested and verified. Connector end faces can be viewed safely and images can be captured and stored for future reference. A Pass/Fail analysis function evaluates the connector condition and automatically inspects the end face for defects and scratches in accordance with the IEC61300-3-35 standard.

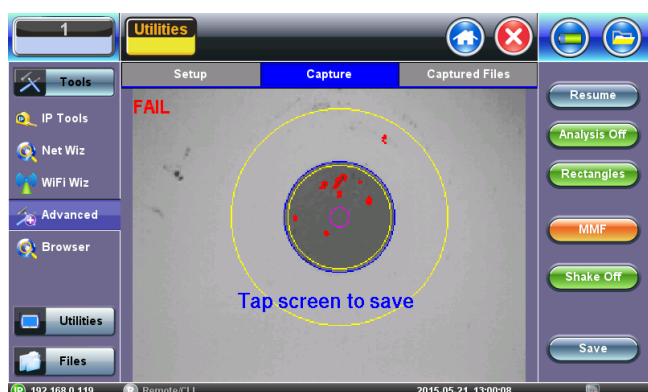

## Visual Fault Locator (VFL)

The optional Visual Fault Locator is a useful tool to identify poor connections, bad fusion splices and macrobends in fiber management closures. Operating at 650 nm, this visible source offers up to 5 km (3 miles) of range.

## Optical Light Source (OLS)

The OTDR port can also operate as a stabilized CWDM light source for loss or end-to-end continuity testing. The source can also be modulated for use with industry standard fiber identifiers.

## ReVeal RXTS PC software

ReVeal RXTS is an all-in-one software tool included with every RXT-4112 CWDM OTDR. The Windows compatible software enables the transfer of test data and other setup criteria between the tester and a PC.

Features include:

- Create test profiles and Pass/Fail thresholds offline to eliminate setup errors
- Archive test results and related installation information
- Generate professional acceptance reports
  - OTDR traces
  - Certification loss results/OPM loss results
  - Connector end-face images from Fiber Inspection scope
- Batch editing of OTDR traces using embedded Fiberizer utility
- Multi-language support including English, French, German, Spanish, Portuguese, and Russian

## Optical Power Meter (OPM)

An optional Optical Power Meter (OPM) can be fitted to measure absolute or relative optical power levels. The OPM incorporates a highly sensitive and stable InGaAs detector with 16 calibrated CWDM calibrated wavelengths providing accurate level measurements from +10 to -65 dBm.

### PON Network Installation

The PONT OPM option is designed for ONT splitter installation testing and rapid ONT troubleshooting. The OPM measures downstream signals simultaneously using PON specific wavelength filters and a specialized photo detector. Both 1490 nm (data) and 1550 nm (video) power levels at the ONT or other FTTx PON test points can easily be verified.

### Test Results

OPM test data can be saved to internal memory using the same file-naming convention applied to OTDR traces. Saved files can be printed directly to pdf or exported to a PC for offline report generation.

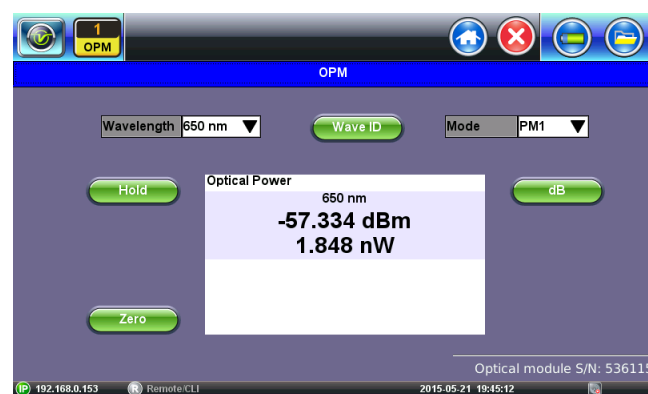

## Switchable Adapters

The OTDR and OPM interfaces accept VeEX thread-on adapters, which can be swapped out in a matter of seconds. The UCI (Universal Connector Interface) and removable adapters interface with a variety of industry standard connector styles fitted with either angled or non-angled connector versions. A protective dust cap to protect the adapter from dirt and other contaminants is also included.





## OTDR Trace Analysis and Documentation

### Fiberizer™ Desktop

Fiberizer Desktop is a standalone PC software application to analyze traces acquired by the RXT-4112 OTDR. Supplied as a standard accessory, Users can edit traces manually, create event tables, generate reports using built-in templates and much more. This viewer displays trace files conforming to Telcordia (Bellcore) GR-196 & SR-4731 \*.sor formats, and offers both 2-point and 5-point loss measurement modes. It also supports batch processing, a very useful feature for analyzing multiple fibers in a single cable. The software does not require Internet access to operate, but it can be interfaced with Fiberizer Cloud OTDR trace viewer at any time.

### Work from Anywhere, Anytime

#### Fiberizer™ Cloud

Fiberizer Cloud not only empowers the OTDR, but also the Workforce. Going way beyond traditional OTDR reporting methods or concepts, this cloud-based solution provides superior centralized test data management capabilities including powerful web based trace analyses. You can work from almost anywhere, at anytime because Fiberizer Cloud is a full online web service.

#### Streamlining onsite data reporting

Fiber technicians and contractors tasked to validate new fiber installations or restoring cable routes after an outage are generally obliged to submit measured data (.sor files) and related documentation to the network operator as proof of delivery before being paid. Valuable time however is often wasted after the onsite work is completed, because critical test files are usually first stored to some local storage media before being transferred to a colleague via email for verification and further reporting.

Fiberizer Cloud streamlines this information exchange, eliminating costly paper, e-mail or other time consuming communication methods - instead, time wastage can be avoided by transferring traces of jobs completed directly from the OTDR to Fiberizer Cloud. Professional PDF or MS Excel reporting functionality is also available, and users can create their own templates for reports. Bi-directional analysis of OTDR traces, tested from both ends of the optical fiber, can also be performed.



### Fiberizer Cloud Connectivity

Pair the RXT-4112 OTDR Multiservice tester via Bluetooth to a mobile Smartphone, Laptop or Tablet PC and efficiently upload OTDR test data directly to the Cloud server using any available wireless technology (3G, WiFi).

### Total Compatibility

Fiberizer Cloud is compatible with both Windows and MacOS browsers, not limiting users to PC platforms only. OTDR trace files in Telcordia (Bellcore) GR-196 & SR-4731 \*.sor formats are securely transferred via HTTPS connection, a fast reliable communication protocol commonly used in today's Internet applications. Another outstanding feature is compatibility with other OTDR vendor trace data formats, so users can reference or compare other OTDR traces and vice versa.

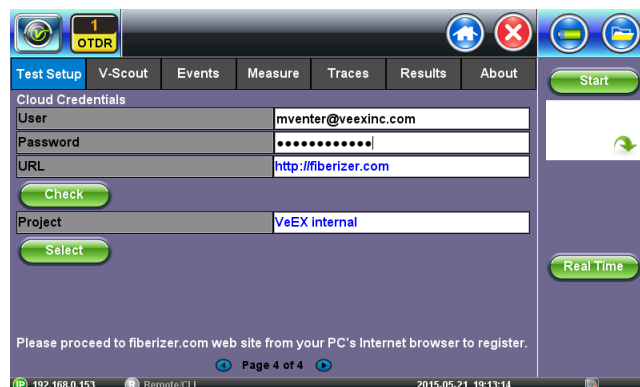

**Optical**

OTDR Parameter	Module A	Module B	Module C	Module D	Module E
Wavelength (nm)	1550/1570/1590/1610	1470/1490/1510/1530	1350/1410/1430/1450	1270/1290/1310/1330	1430/1450/1625/1650
Wavelength Accuracy (± nm)	20/3/3/3	3/3/3/3	3/3/3/3	3/3/3/3	3/3/10/10
Dynamic Range (db)	40/40/40/40	40/40/40/40	40/40/40/40	40/40/40/40	40/40/40/40
Pulse Widths (ns)	3, 10, 25, 100, 300, 500, 1000, 3000, 10000, 20000				
Event Dead Zone (m)	< 1				
Attenuation Dead Zone (m)	< 4				
Distance Display Range (km)	0.5 to 240				
Distance Units	Kilometers, Meters, Kilofeet, Feet, Miles				
Distance Accuracy (m) <sup>5</sup>	± (0.5 + resolution + 2x10 <sup>-5</sup> x L)				
Sampling Resolution (m)	0.16 to 7.6				
Sampling Points	Up to 128,000				
Loss Resolution (dB)	0.001				
Attenuation Linearity (dB/dB)	± 0.05				
Group Index Range (IoR)	1,3000 to 1,7000				
Measurement Time	User defined, Auto (30s)				
Internal Memory Capacity (SD card)	>5,000 traces, Bellcore GR196 and Telcordia SR-4731 sor format				
Fiber Analysis	Automatic, event table, user defined PASS/FAIL thresholds				
Intelligent Link Mapping (V-Scout)	Intelligent Link Mapping using intuitive icons derived from multiple test acquisitions				
Fiber Type	Single mode, 9/125 µm				
OTDR Laser Safety	IEC 60825-1, Class 1M				
Optical Connectors (OTDR/LS)	Universal 2.5 mm interface, FC/SC/ST/LC adaptors optional				

Optical Test Options	Singlemode
Visual Fault Locator (VFL)	Optional
-Wavelength (nm)	650 ± 10 nm
-Output (mW)	Max 1 mW
-Laser Safety	IEC 60825-1, Class II
Light Source (LS) - (O/P shared with OTDR)	Optional
-Wavelengths (nm)	Based on module type
-Output Power (dBm)	> -4
-Level Instability (dB)	Better than ± 0.05 (15 min)
Optical Power Meter (OPM)	Optional
-Calibrated Wavelengths (nm)	All ITU-T recommended 694.2 wavelengths including 850, 1650 nm
-Power Range (dBm) - PM1, PM2	-65 to +10 (PM1) / -50 to +25 (PM2)
-Accuracy, %	± 5
-Linearity, %	± 2.5
Optical Connectors (VFL/OPM)	Universal 2.5 mm interface, FC/SC/ST/LC adaptors optional

Hardware Options
Standard OPM (+10 dBm)
Visual Fault Locator (650 nm)
Light Soure (per OTDR laser fitted)

**Notes:**

1. Unless noted, all specifications are valid at 23°C ± 2°C (73.4°F ± 3.6°F) using FCUPC connectors
2. Typical dynamic range after three-minute averaging and SNR = 1
3. Typical dead zone using 3 ns pulse and reflections below -45 dB
4. Typical dead zone using 5 ns pulse and reflections below -55 dB
5. Excludes uncertainty due to fiber refractive index (IoR) setting

## General Specifications

Size	290 x 140 x 66 mm (W x H x D) 11.40 x 5.50 x 2.60 in
Weight	Less than 3 kg (less than 6.6 lb)
Battery	Li-ion smart battery, 5200 mAh 10.8 VDC
Power Supply (AC Adaptor)	Input: 100-240 VAC, 50-60 Hz Output: 15 VDC, 5.33 A
Operating Temperature	0°C to 45°C (32°F to 113°F)
Storage Temperature	-20°C to 70°C (-4°F to 158°F)
Humidity	5% to 95% non-condensing
Display	TFT 7" full color touch-screen display
Ruggedness	Survives 1m drop to concrete on all sides
Management Interfaces	USB, RJ45, 10/100-T Ethernet, Bluetooth (optional), Data Card/GPS (optional) WiFi (optional)
Languages	Multiple languages can be supported
System Memory	128 Mbyte RAM, 16 Gbyte SD



VeEX Inc.  
2827 Lakeview Court  
Fremont, CA 94538 USA  
Tel: +1.510.651.0500  
Fax: +1.510.651.0505  
www.veexinc.com  
customercare@veexinc.com

© 2019 VeEX Inc. All rights reserved.  
VeEX is a registered trademark of VeEX Inc. The information contained in this document is accurate. However, we reserve the right to change any contents at any time without notice. We accept no responsibility for any errors or omissions. In case of discrepancy, the web version takes precedence over any printed literature.  
D05-00-118P C00 2019/06